

# Colo-Rectal / Intestinal Surgery



## Instrument Details

Clamp Anastomosis  
Doyen Occlusion

This clamp incorporates non-traumatic jaw and non-reflective finish.

## Stock Code

18/0103/1 - 23cm Str

18/0103/2 - 23cm Cvd

**Instrument Details**

Clamp Anastomosis  
De Martell

This set comprises of one  
clamp, three segments  
and one locking lever.



**Stock Code**

23/1569

# Colo-Rectal / Intestinal Surgery



## Instrument Details

Clamp Anastomosis  
Purse String Forcep

This forcep is designed  
to form a perfect purse  
string.

## Stock Code

18/5186 - 25cm  
55mm Jaw

18/5186/1 - 30cm  
55mm Jaw

18/5186/2 - 33cm  
55mm Jaw

**Instrument Details**

Clamp Anastomosis  
Zackery Cope

Comprising of  
compression handle, 3  
segments and 1 key.



**Stock Code**

23/0170

# Colo-Rectal / Intestinal Surgery

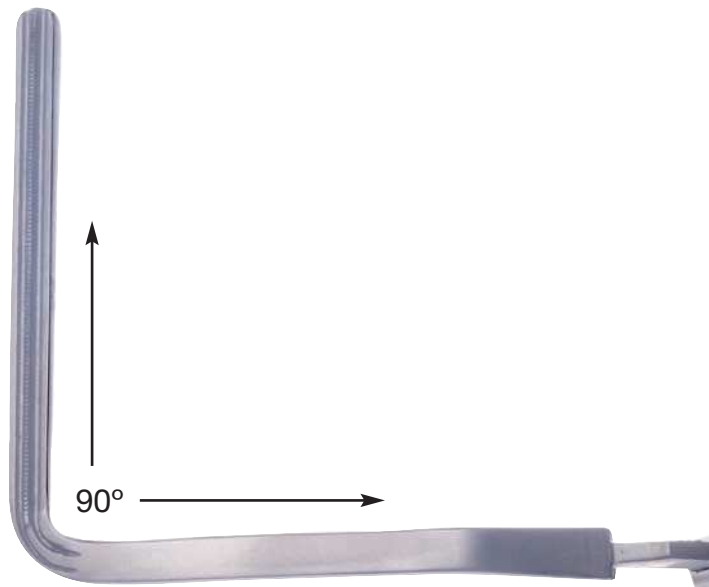

**AMAAX** INTERNATIONAL

## Instrument Details

Clamp Low Resection  
Bowel - Left

This instrument has a far superior clamping action than conventional clamps and incorporates non-crushing atraumatic jaws.

## Stock Code

18/1227/1 - 40mm Jaw  
30cm

18/1227/3 - 50mm Jaw  
30cm

18/1227/5 - 60mm Jaw  
30cm

18/1277/7 - 70mm Jaw  
30cm

[www.amaaxint.com](http://www.amaaxint.com)

**Instrument Details**

Clamp Low Resection  
Bowel - Right

This instrument has a far superior clamping action than conventional clamps and incorporates non-crushing atraumatic jaws with extra strength.

**Stock Code**

18/1227 - 40mm Jaw  
30cm

18/1227/2 - 50mm Jaw  
30cm

18/1227/4 - 60mm Jaw  
30cm

18/1277/6 - 70mm Jaw  
30cm

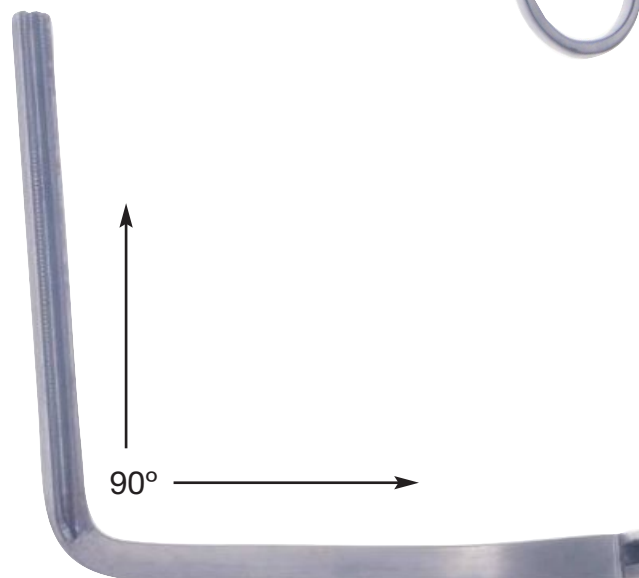

# Colo-Rectal / Intestinal Surgery



**AMAAX** INTERNATIONAL

## Instrument Details

Clamp Low Resection  
Dickens Bowel

This clamp has a straight  
shank and a double  
atraumatic jaw.

## Stock Code

18/6181 - 28cm 1st  
Curve 30° angle

18/6181/1 28cm  
2nd Curve 45° angle

[www.amaaxint.com](http://www.amaaxint.com)

**Instrument Details**

Clamp Low Resection  
Hayes

This clamp is available  
two jaw lengths with a  
non reflective finish.

**Stock Code**

18/1735/1 - 26cm  
6cm Jaw

18/1735/2 - 28cm  
8cm Jaw



# Colo-Rectal / Intestinal Surgery



## Instrument Details

Clamp Low Resection  
Lloyd Davis

With longitudinal none  
crushing serrations.

## Stock Code

18/1720 - 30cm

**Instrument Details**

Clamp Low Resection  
Resano Bowel

This clamp features an angled shank and 90 degree jaw. This instrument has double non-traumatic serrations.

**Stock Code**

18/6177 - 30.5cm



---

**Instrument Details**

---

Clamp Low Resection  
Hayes

This clamp is available in  
two jaw lengths with a  
none reflective finish.

---

**Stock Code**

---

18/1735/1 - 26cm  
6cm Jaw

18/1735/2 - 28cm  
8cm Jaw



**Instrument Details**

Clamp Low Resection  
Rectal Stump Clamp

The design of this clamp allows unobstructed vision during bowel excision giving firm even pressure, with none traumatic jaws.

**Stock Code**

18/4614 - 30cm



# Colo-Rectal / Intestinal Surgery



## Instrument Details

Tissue Forcep  
Allis

This forcep features a 4:5 toothed jaw and extra length for optimum tissue control. This instrument has a non-reflective finish.

## Stock Code

14/6070/7 - 30cm  
5:6 Jaw

14/6070/8 - 30cm  
4:5 Jaw

**Instrument Details**

Tissue Forcep  
Babcock

Offering well balanced  
tissue control. Available  
in various sizes.

**Stock Code**

- 14/6072/1 - 16.5cm
- 14/6072/2 - 20cm
- 14/6072/3 - 23cm
- 14/6072/4 - 30cm
- 14/6072/5 - 33cm
- 14/6072/6 - 36cm

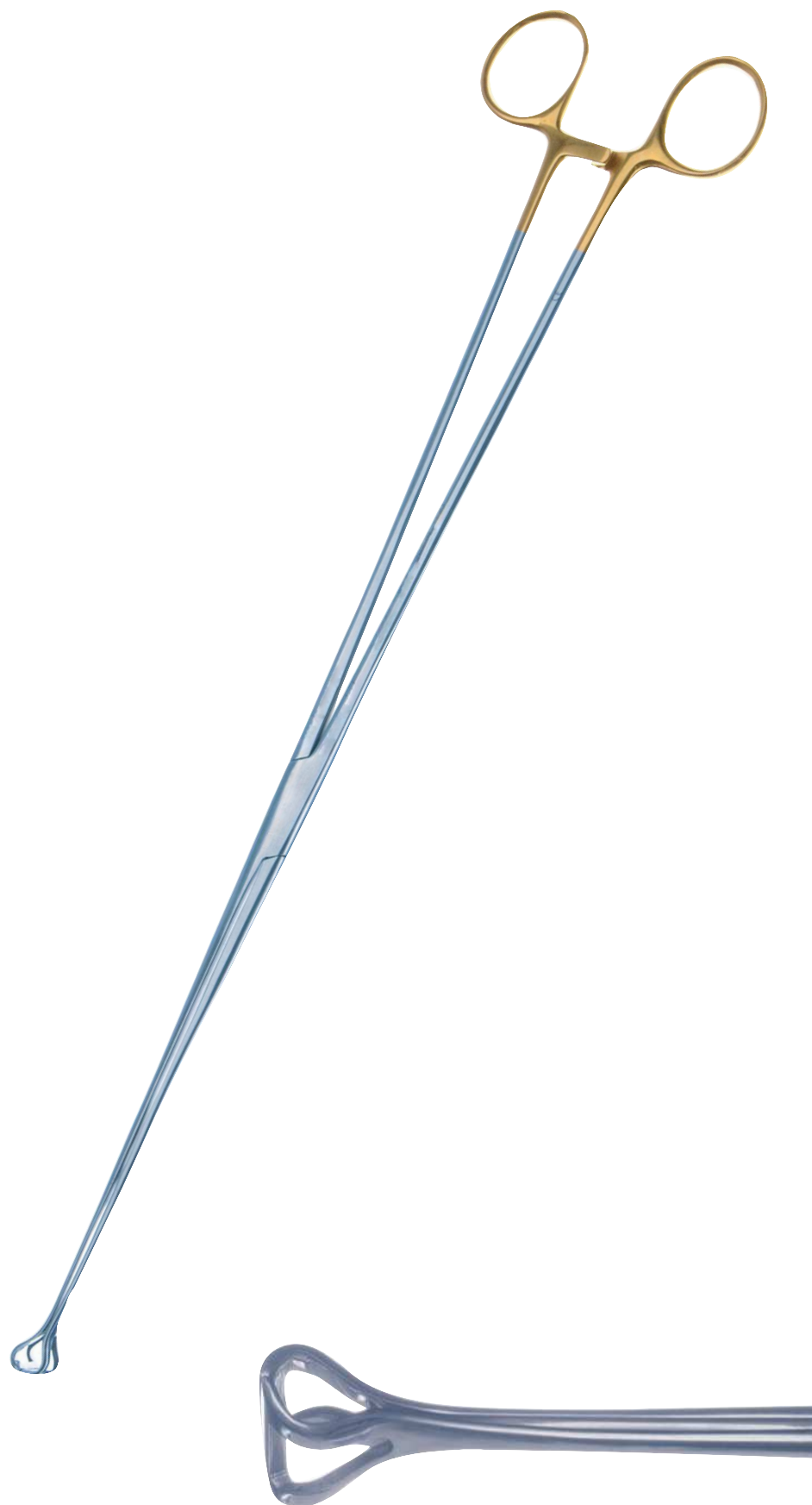

# Colo-Rectal / Intestinal Surgery



## Instrument Details

Tissue Forcep  
Duval

Maximises tissue

## Stock Code

14/6074 - 19cm  
13mm Jaw

21/1423/2 - 19cm  
25mm Jaw

14/6074/2 - 30cm  
13mm Jaw

14/6074/1 - 30cm  
25mm Jaw

**Instrument Details**

Tissue Forcep  
Lahey Cholestectomy

This forcep features longitudinal serrations, also available with black finish.

Other instruments are also available with blacked finish. Contact our sales team for more details.

**Stock Code**

Non-reflective finish  
14/1707/3 - 28cm  
14/1707/4 - 30cm  
14/1707/5 - 33cm

Blacked finish  
14/1707/6 - 28cm  
14/1707/7 - 30cm  
14/1707/8 - 33cm

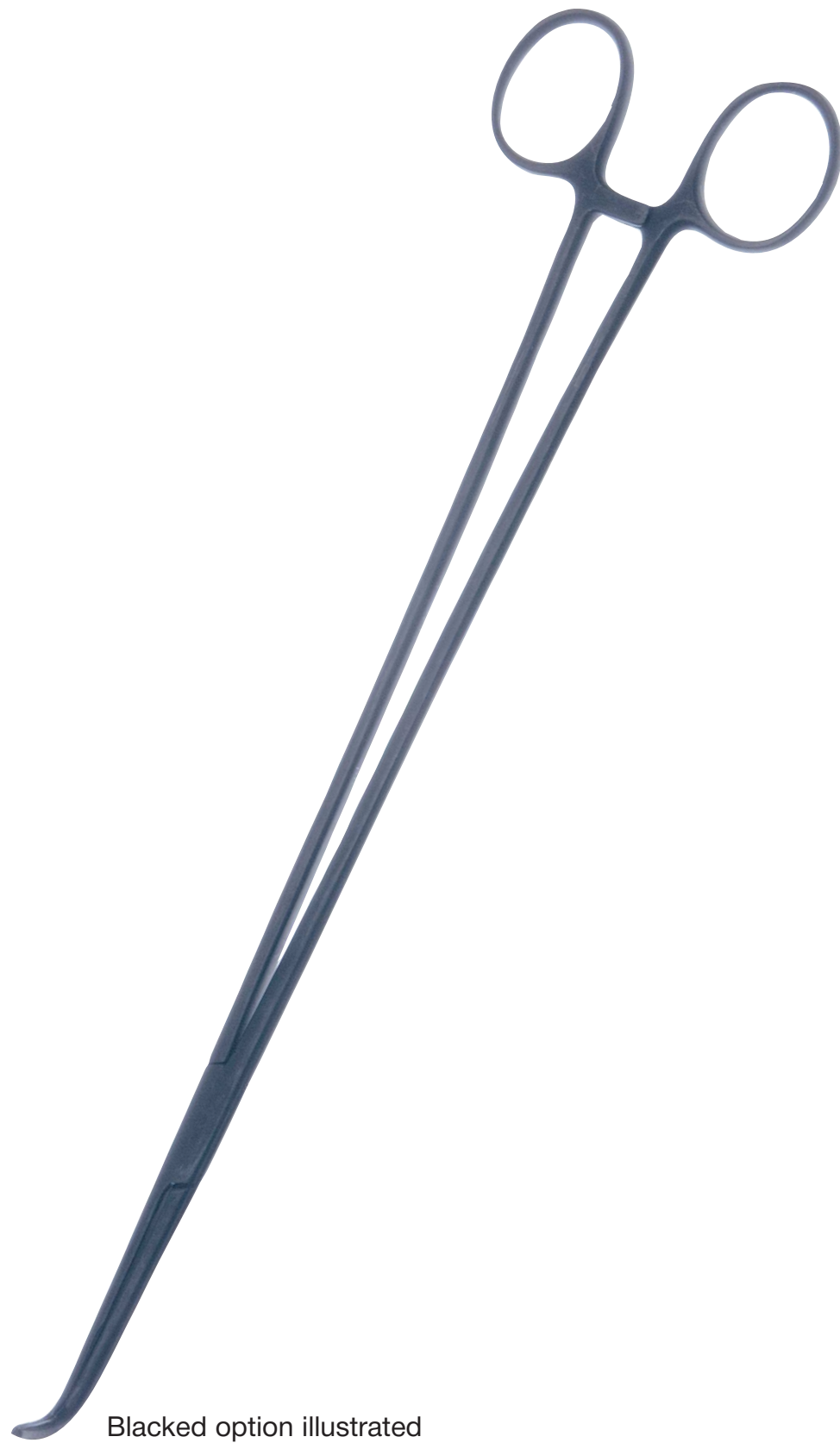

# Colo-Rectal / Intestinal Surgery



## Instrument Details

Tissue Forcep  
O'Shaughnessy Artery

This forcep features an extra curved distal tip and is available in a none reflective finish.

## Stock Code

14/1525/9 - Cvd 30cm  
14/1525 - Strong Cvd 30cm  
14/1525/10 - Cvd 33cm  
14/1525/11 - Strong Cvd 30cm  
14/1525/12 - Cvd 36cm  
14/1525/13 - Strong Cvd 36cm

**Instrument Details**

Tissue Forcep  
O'Shaugnessy Dissecting

**Stock Code**

14/1525/8 - 30cm  
14/1525/14 - 33cm  
14/1525/15 - 36cm  
All 90° angle



# Colo-Rectal / Intestinal Surgery



## Instrument Details

Tissue Forcep  
St George Seizing

This forcep is used in conjunction with a McGivney Bander for retrieving a quantitative anal wall tissue sample.

## Stock Code

18/1211 - 18cm

**Instrument Details**

Dissecting Forcep  
Debakey

Atraumatic jaws for  
precise tissue control.

**Stock Code**

21/1609/25 - 30cm  
Straight 1.5mm Jaw

21/1609/21 - 30cm  
Straight 3mm Jaw

21/1609/22 - 33cm  
Straight 3mm Jaw

21/1609/23 - 36cm  
Straight 3mm Jaw



# Colo-Rectal / Intestinal Surgery



**AMAAX** INTERNATIONAL

## Instrument Details

Dissecting Forcep  
Debakey Angled

Atraumatic jaws for  
precise tissue control.

## Stock Code

21/1609/29 - 30cm  
2mm Jaw

21/1609/30 - 33cm  
3mm Jaw

21/1609/31 - 36cm  
3mm Jaw

[www.amaaxint.com](http://www.amaaxint.com)

**Instrument Details**

Dissecting Forcep  
Debakey Curved

Atraumatic jaws for  
precise tissue control.

**Stock Code**

21/1609/26 - 30cm  
2mm Jaw

21/1609/27 - 33cm  
3mm Jaw

21/1609/28 - 36cm  
3mm Jaw



# Colo-Rectal / Intestinal Surgery



## Instrument Details

Dissecting Forcep  
Mayo Russian

## Stock Code

14/1652/4 - 25.5cm  
14/1652/5 - 30cm  
14/1652/6 - 33cm  
14/1652/7 - 36cm

**Instrument Details**

Dissecting Forcep  
Officer

This forcep is available  
with serrated 2:3 or 4:5  
teeth and features a non-  
reflective finish.

**Stock Code**

18/1626/6 - 25.5cm  
2:3 Jaw

18/1626/9 - 25.5cm  
4:5 Jaw

18/1626/10 - 30cm  
2:3 Jaw

18/1626/11 - 30cm  
4:5 Jaw

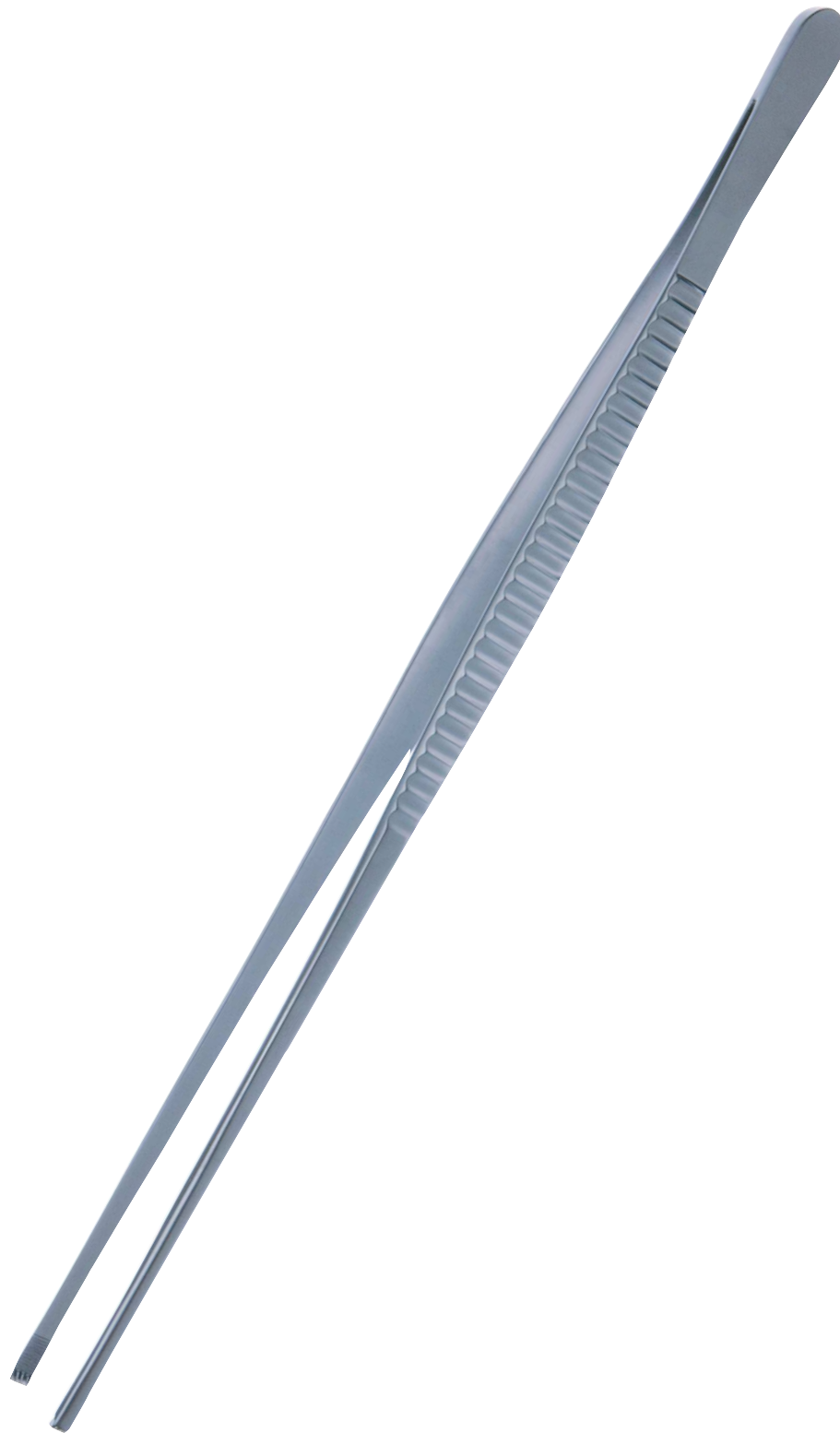

# Colo-Rectal / Intestinal Surgery



## Instrument Details

Dissecting Forcep  
St Marks

Available with a serrated  
or toothed jaw, and a  
none reflective finish.

## Stock Code

18/1629/4 - 27.5cm 1:2 Toothed  
18/1629/2 - 29cm 1:2 Toothed  
18/1629/6 - 33cm 1:2 Toothed  
18/1629/8 - 36cm 1:2 Toothed

18/1629/3 - 27.5cm Serrated  
18/1629/1 - 29cm Serrated  
18/1629/5 - 33cm Serrated  
18/1629/7 - 36cm Serrated

**Instrument Details**

Scissor  
Abels Abdominal  
32cm curved

The Abels scissor features all Professional A.E.A. Surgical's manufacturing refinements whilst incorporating bows that are smaller to accommodate the surgeon with smaller hands.

If you require any information about other small bow scissors in our range, please contact our sales team.

**Stock Code**

14/0015/1 - 32cm  
Standard Curve

14/0015/2 - 32cm  
Strong Curve

Small Bows



# Colo-Rectal / Intestinal Surgery



Small Bows

## Instrument Details

Scissor  
Abels Abdominal  
32cm straight

The Abels scissor features all Professional A.E.A. Surgicals manufacturing refinements whilst incorporating bows that are smaller to accommodate the surgeon with smaller hands.

If you require any information about other small bow scissors in our range, please contact our sales team.

## Stock Code

14/0015 - 32cm  
Straight

**Instrument Details**

Scissor  
Fistula

This scissor incorporates  
a precision tenotomy tip  
for fine dissection of  
fistula tissue.

**Stock Code**

18/1659/1 - 18cm  
Straight

18/1659/2 - 23cm  
Straight

18/1659/3 - 18cm  
Curved

18/1659/4 - 23cm  
Curved



Tenotomy Tip

# Colo-Rectal / Intestinal Surgery



## Instrument Details

Scissor  
Lloyd Davis Strong Curve

Including all the Lloyd Davis features but with a strong curve. Also available in the surecut pattern.

## Stock Code

18/1694/16 - 30cm  
18/1694/17 - 33cm  
18/1694/15 - 36cm

**Instrument Details**

Scissor  
Lloyd Davis Lightweight

A well balanced  
lightweight scissor  
manufactured to the  
distinctive Lloyd Davis  
pattern but lighter.

**Stock Code**

With Hard Edge:  
13/1009/21 - 30cm Cvd  
13/1009/10 - 33cm Cvd  
13/1009/23 - 35cm Cvd

With Hard Edge:  
13/1009/20 - 30cm Str  
13/1009/11 - 33cm Str  
13/1009/22 - 35cm Str

Without Hard Edge:  
13/1694/12 - 30cm Cvd  
13/1694/4 - 33cm Cvd  
13/1694/14 - 35cm Cvd

Without Hard Edge:  
18/1694/11 - 30cm Str  
18/1694/3 - 33cm Str  
18/1694/13 - 35cm Str



# Colo-Rectal / Intestinal Surgery



## Instrument Details

Scissor  
Lloyd Davis Surecut

This unique scissor incorporates a lower serrated cutting blade to ensure precise dissection of the heaviest tissue. All the surecut range of scissors incorporate distinctive black bows.

## Stock Code

12/1009/5 - 30cm Cvd  
12/1009/7 - 33cm Cvd  
12/1009/15 - 35cm Cvd

12/1009/4 - 30cm Str  
12/1009/6 - 33cm Str  
12/1009/14 - 35cm Str

12/1009/17 - 30cm  
Strong Cvd  
12/1009/18 - 33cm  
Strong Cvd

**Instrument Details**

Scissor  
Metzenbaum  
Strong Curve

Strongn curve  
Metzenbaum available in  
various lengths.

**Stock Code**

14/0089/22 - 30cm  
14/0089/23 - 33cm  
14/0089/21 - 36cm



# Colo-Rectal / Intestinal Surgery



## Instrument Details

Scissor  
Metzenbaum Hard Edge

This scissor incorporates specially hardened blades for dissection of heavy tissue. Designed with a delicate cutting action and distinctive gold bows.

## Stock Code

Hard Edge

13/1005/22 - 30cm Str

13/1005/14 - 33cm Str

13/1005/15 - 36cm Str

13/1005/16 - 30cm Cvd

13/1005/17 - 33cm Cvd

13/1005/18 - 36cm Cvd

**Instrument Details**

Scissor  
Metzenbaum

This scissor is available  
in three different lengths  
offering perfect balance  
with optimum tissue  
dissection.

**Stock Code**

14/0089/6 - 30.5cm Str  
14/0089/14 - 33cm Str  
14/0089/15 - 36cm Str

14/0089/12 - 30.5cm Cvd  
14/0089/17 - 33cm Cvd  
14/0089/18 - 36cm Cvd



# Colo-Rectal / Intestinal Surgery



## Instrument Details

Scissor  
Seedhouse

This exclusive scissor has been designed with a precise 90° cutting action for dissection of the bowel.

Used in conjunction with the Seedhouse Bowel Clamp.

## Stock Code

18/1251 - 27cm  
90° cutting angle

**Instrument Details**

Haemastat  
Scissor

Designed in conjunction  
with Mr Ahmad  
Consultant Colorectal  
Surgeon, Scunthorpe  
District Hospital.

This Metzenbaum pattern  
scissor incorporates a  
Monopolar jaw.

**Stock Code**

18/4606 - 30cm  
18/4606/1 - 33cm  
18/4606/2 - 36cm



# Colo-Rectal / Intestinal Surgery



Slight Curve

## Instrument Details

Haemastat  
Johnsons Artery Forcep

This Artery Forcep  
features a short curved  
jaw, for powerful  
Haemastatic control.

## Stock Code

18/4605 - 28cm  
18/4605/1 - 30cm

---

**Instrument Details**

---

Haemostat  
Kelly Artery Forcep

A medium weight forcep  
with a delicate tip for  
total haemostat control.

---

**Stock Code**

---

14/1514/5 - 28cm Cvd  
14/1514/6 - 30cm Cvd  
14/1514/7 - 33cm Cvd  
14/1514/8 - 36cm Cvd

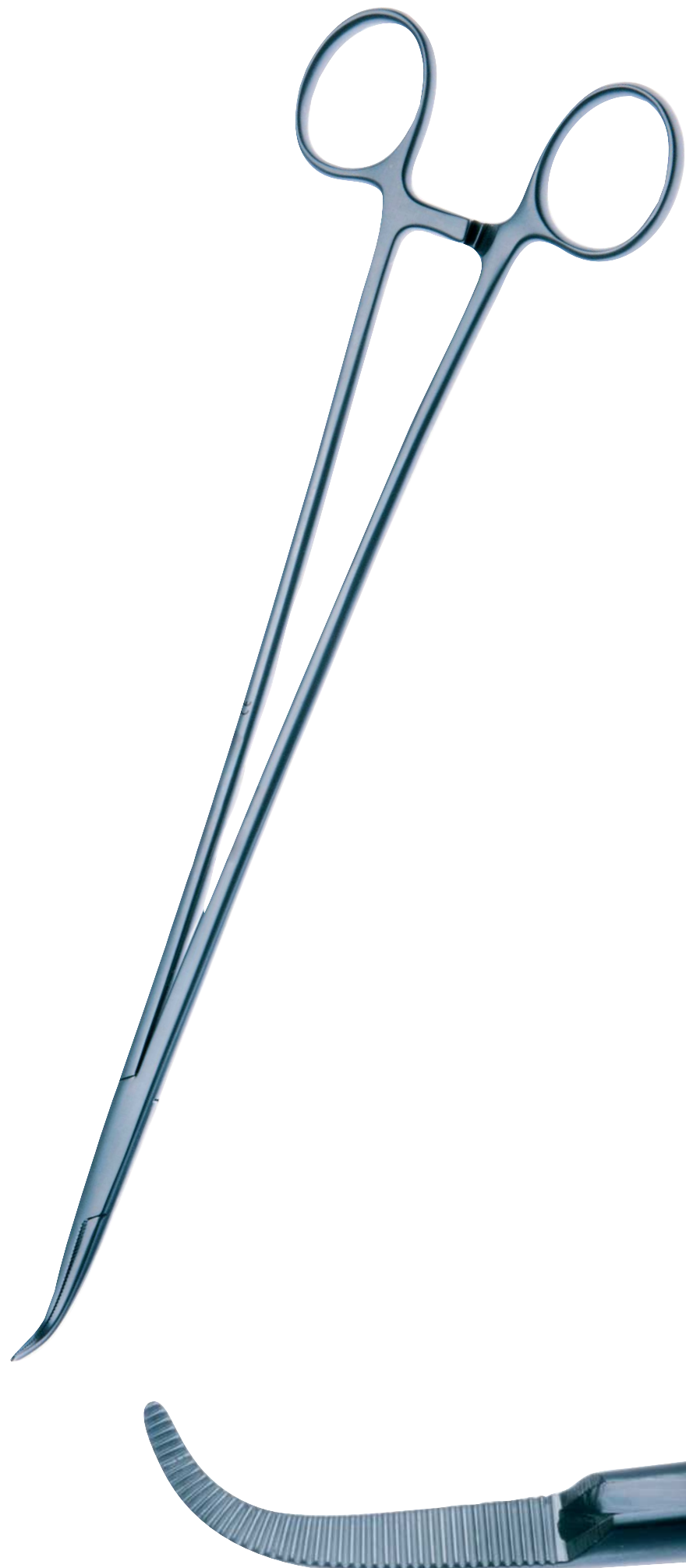

# Colo-Rectal / Intestinal Surgery



## Instrument Details

Haemastat  
Mixer Lahey Forcep

This forcep has medium jaws for delicate haemastatic control.

## Stock Code

14/1521/4 - 30cm  
14/1521/5 - 33cm  
14/1521/6 - 36cm

**Instrument Details**

Haemastat  
Moynihan  
Forcep

A powerful Haemastat  
with short working jaws.

**Stock Code**

23/5598/2 - 22cm

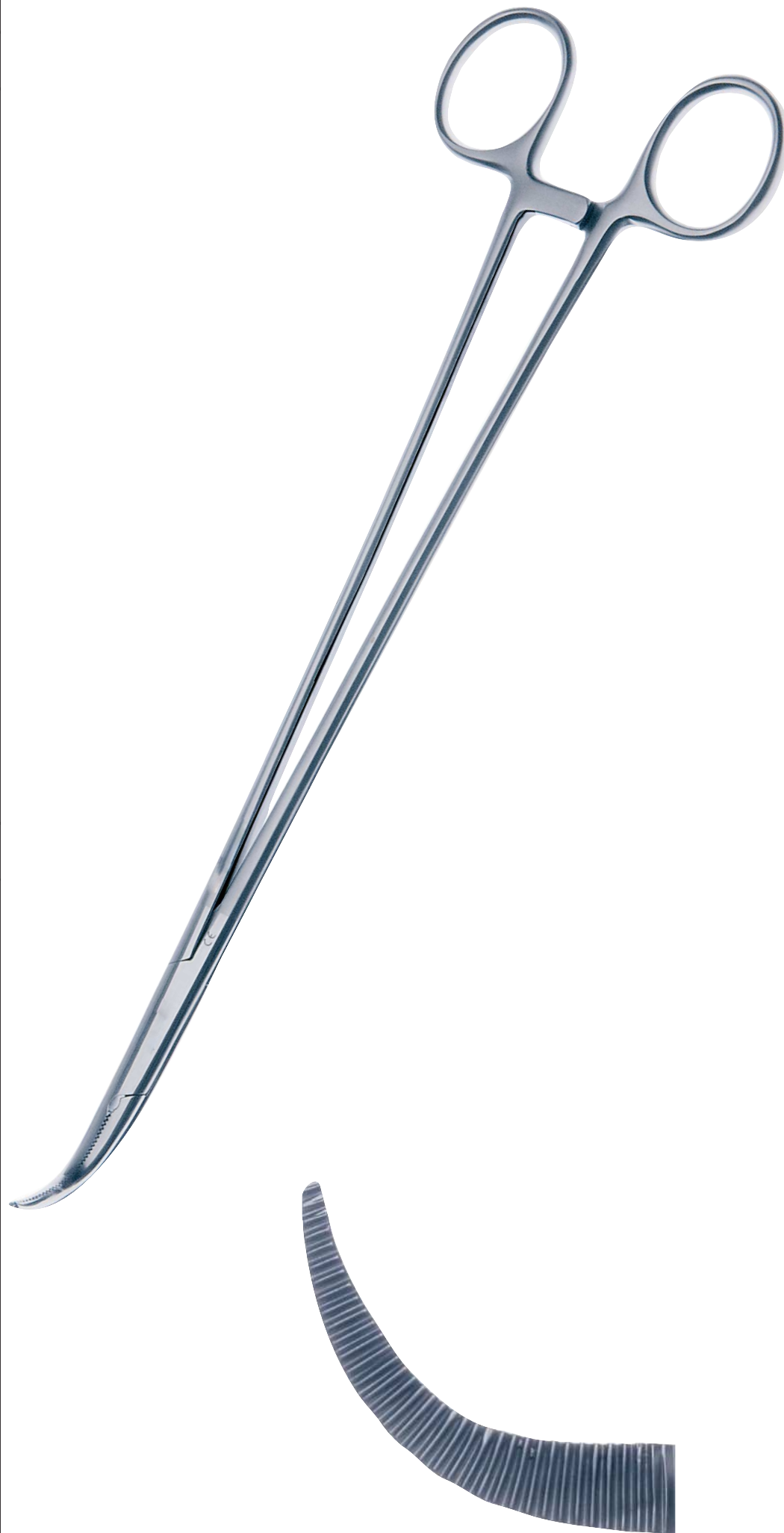

# Colo-Rectal / Intestinal Surgery

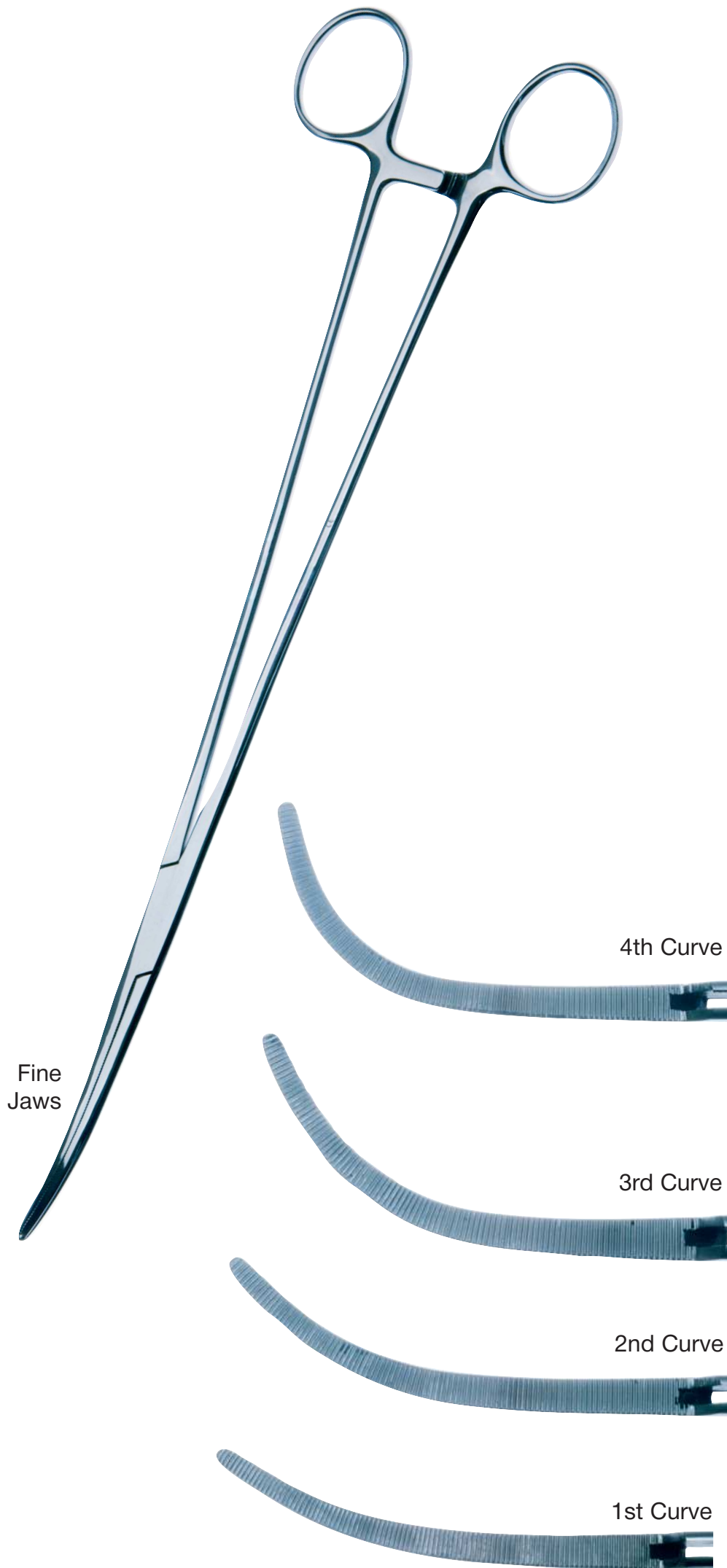

## Instrument Details

Haemastat  
Overholt Artery Forcep

A popular Forcep available  
with 4 fine jaw  
configurations.

## Stock Code

18/1876 - 30cm  
1st Curve

18/1876/1 - 30cm  
2nd Curve

18/1876/2 - 30cm  
3rd Curve

18/1876/3 - 30cm  
4th Curve

**Instrument Details**

Haemostat  
Roberts Artery Forcep

For more information on  
other black finish  
instruments please  
contact us.

**Stock Code**

None Reflective Finish

- 14/1526/5-28cm
- 14/1526/4-30cm
- 14/1526/6 - 33cm
- Blacked Finish
- 14/1526/7 - 28cm
- 14/1526/8 - 30cm
- 14/1526/9 - 33cm

Blacked Finish illustrated



# Colo-Rectal / Intestinal Surgery



2nd Curve



1st Curve



Straight



## Instrument Details

Haemastat  
Seedhouse

This instrument has been designed with double atraumatic jaws to ensure positive clamping when haemostat control is required. It is ideal for deep pelvic procedures. Available in straight, 1st or 2nd curve.

## Stock Code

18/1254/1 - 30cm Str  
18/1254/2 - 30cm 1st  
18/1254/3 - 30cm 2nd

**Instrument Details**

Haemostat  
Spencer Wells Artery  
Forcep

**Stock Code**

14/1530/14 - 25.5cm Cvd

14/1530/12 - 30cm Cvd

14/1530/13 - 25.5cm Str

14/1530/11 - 30cm Str



# Colo-Rectal / Intestinal Surgery

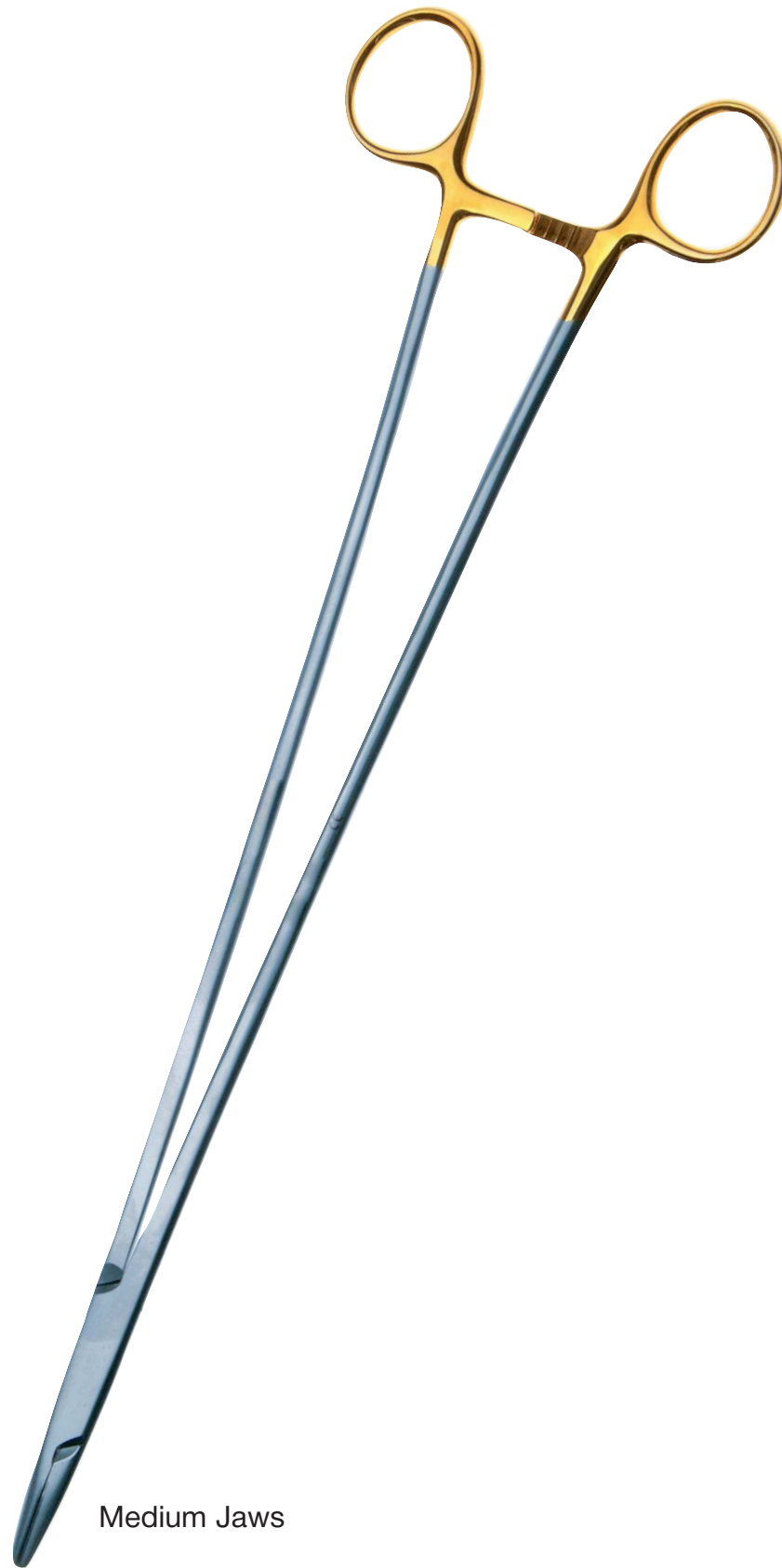

Medium Jaws

## Instrument Details

Needle Holder  
Crilewood, Tungsten  
Carbide

Incorporating Tungsten  
Carbide jaws and  
distinctive gold bows.

## Stock Code

14/1784/7 - 30.5cm  
14/1784/8 - 36cm

---

**Instrument Details**

---

Needle Holder  
Debaquey, Tungsten Carbide

Incorporating Tungsten  
Carbide jaws and  
distinctive gold bows.

---

**Stock Code**

---

14/1785/5 - 30.5cm  
14/1785/6 - 33cm  
14/1785/7 - 36cm

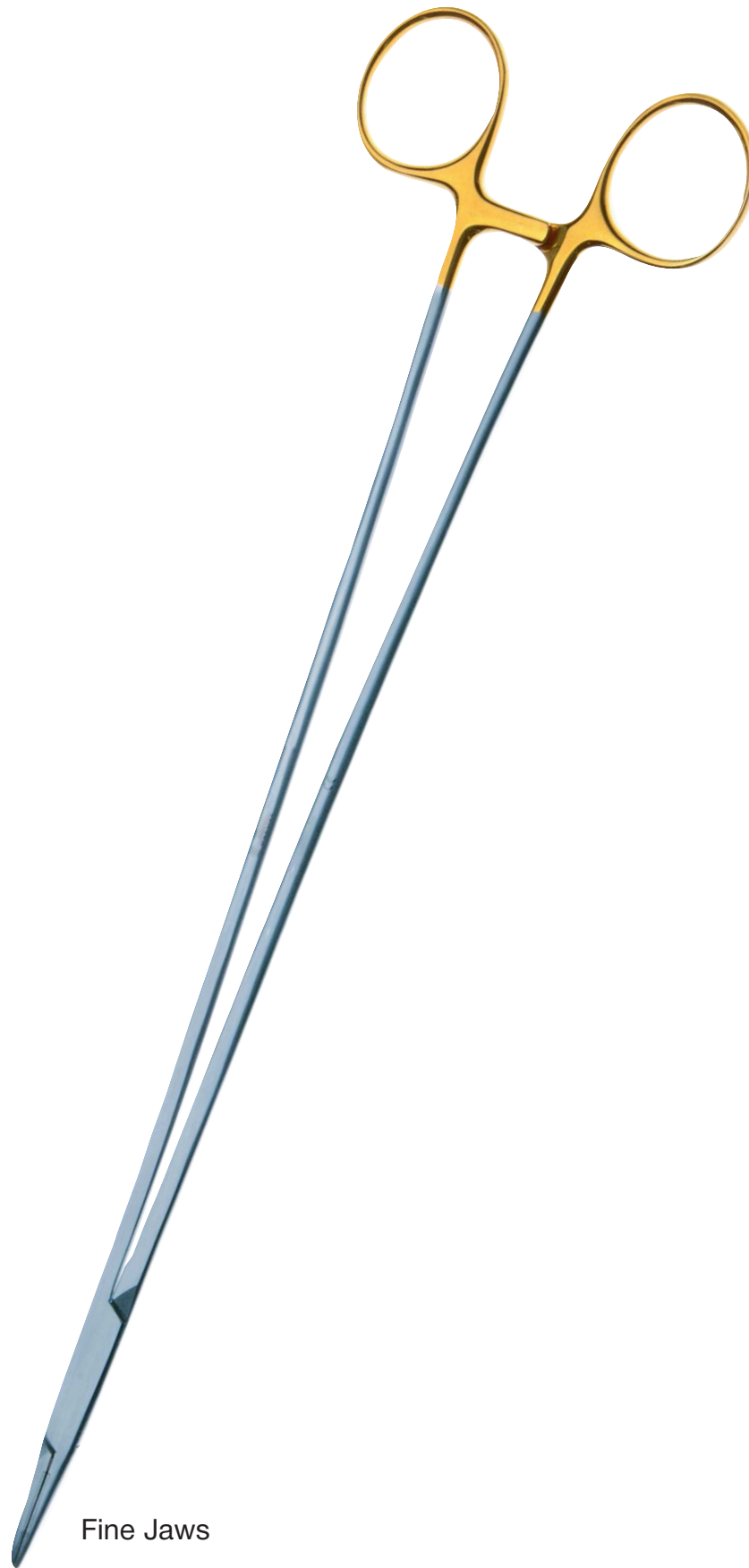

Fine Jaws

# Colo-Rectal / Intestinal Surgery

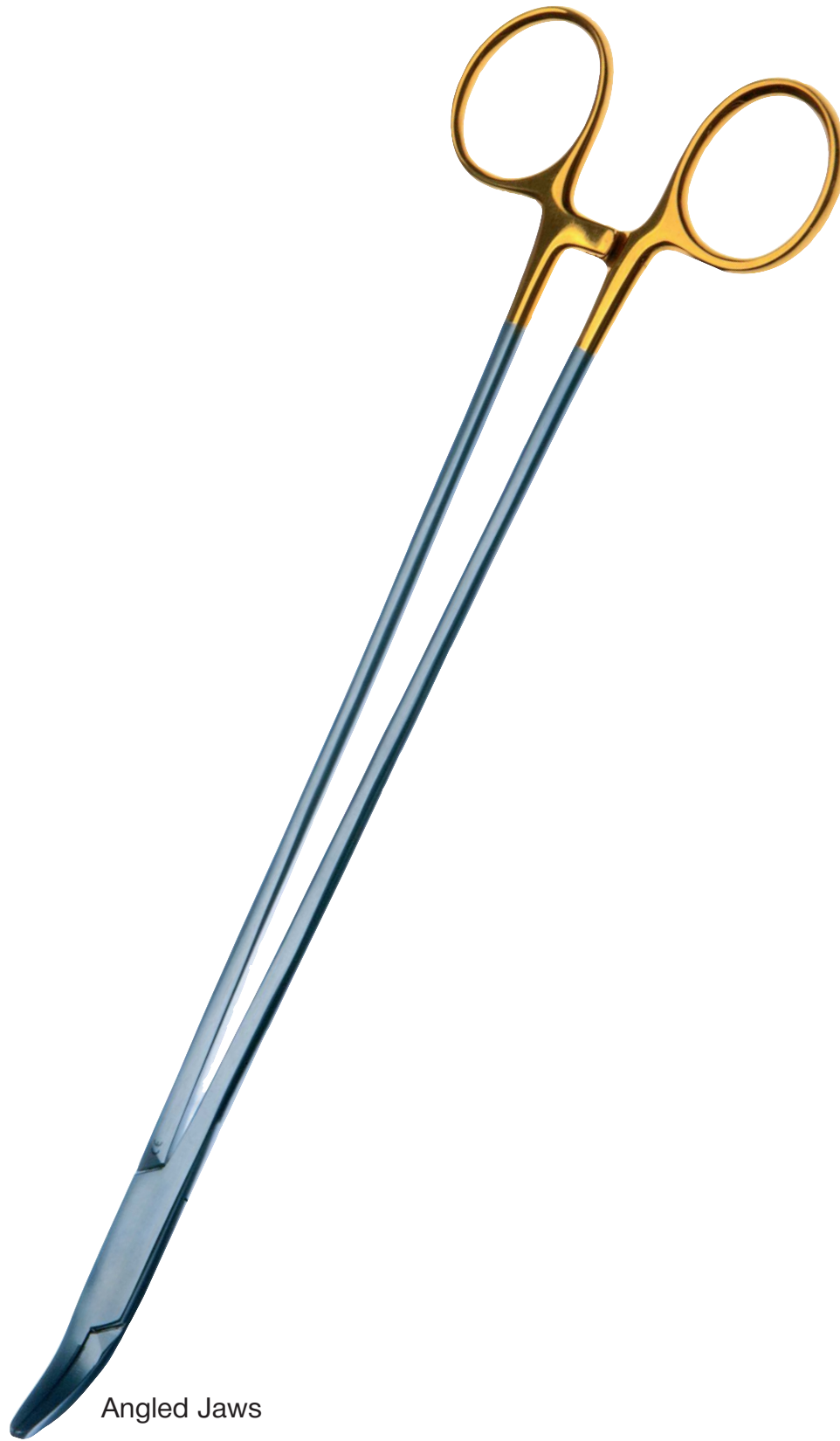

Angled Jaws

## Instrument Details

Needle Holder  
Finochetto, Tungsten  
Carbide

Incorporating Angled  
Tungsten Carbide jaws and  
distinctive gold bows.

## Stock Code

14/1787/2 - 26.5cm  
14/1787/3 - 30cm  
14/1787/4 - 33cm  
14/1787/5 - 36cm

**Instrument Details**

Needle Holder  
Heaney, Tungsten  
Carbide

Incorporating Tungsten  
Carbide jaws and  
distinctive gold bows.

**Stock Code**

14/1791/2 - 25.5cm  
14/1791/1 - 20cm



Curved Jaws



# Colo-Rectal / Intestinal Surgery

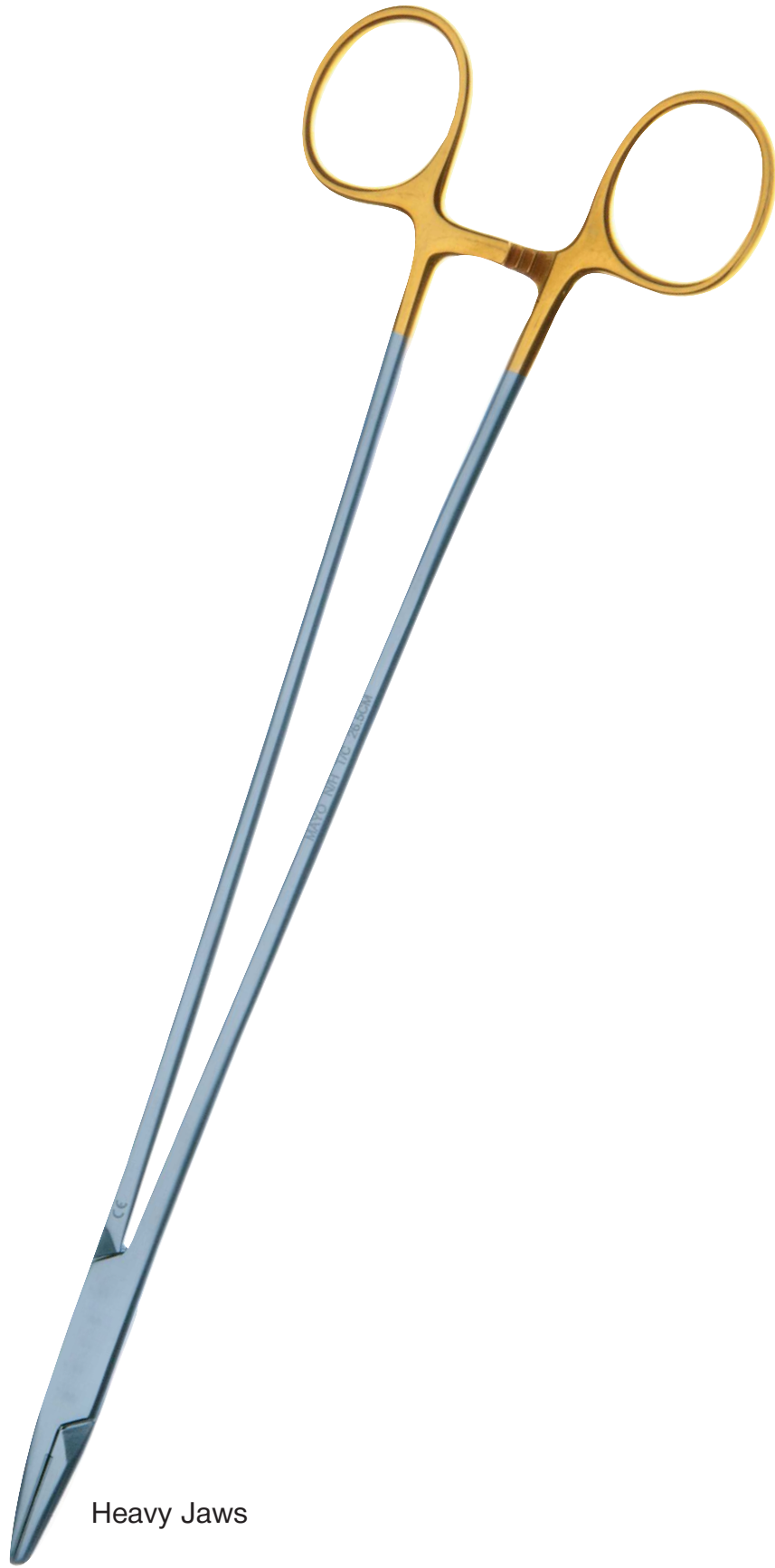

Heavy Jaws

## Instrument Details

Needle Holder  
Mayo Hegar, Tungsten  
Carbide

Extra long needle holder  
with tungsten carbide  
inserts. This instrument  
has a non-reflective finish  
and distinctive gold bows.

## Stock Code

14/1796/11 - 25.5cm  
14/1796/12 - 27cm  
14/1796/13 - 30cm  
14/1796/14 - 33cm  
14/1796/15 - 36cm

---

**Instrument Details**

---

Needle Holder  
Naunton Morgan,  
Tungsten Carbide

This needle holder  
incorporates a converse  
joint for giving extra grip.  
With distinctive gold  
bows.

---

**Stock Code**

---

14/1797/1 - 18.5cm Str  
14/1797/2 - 27cm Str  
14/1797/3 - 18.5 Cvd  
14/1797/4 - 27cm Cvd



# Colo-Rectal / Intestinal Surgery

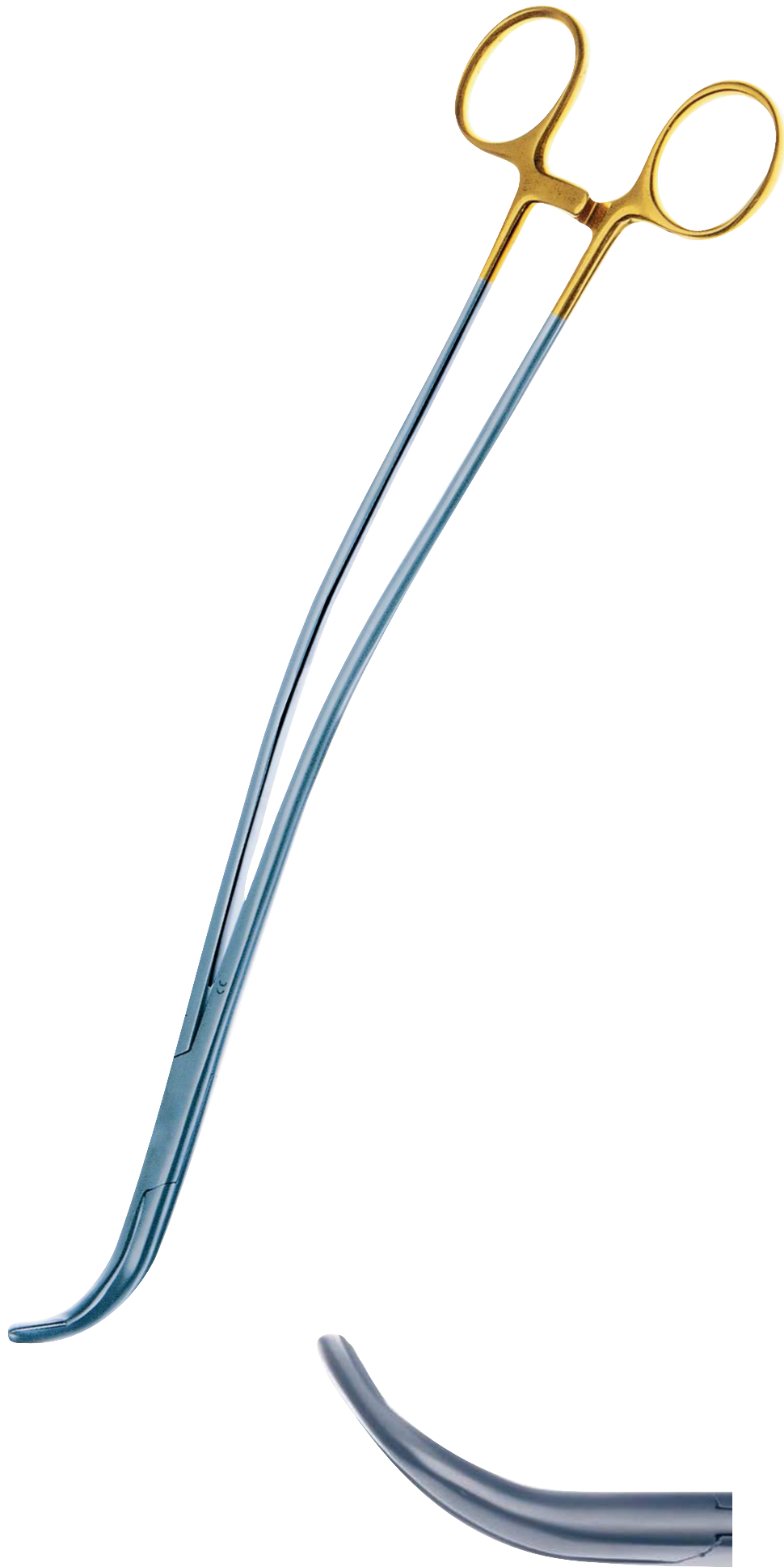

**AMAAX** INTERNATIONAL

## Instrument Details

Needle Holder  
Stratte, Tungsten Carbide

Incorporating Tungsten  
Carbide jaws and  
distinctive gold bows.

## Stock Code

14/1803 - 23cm  
14/1803/1 - 28.5cm

[www.amaaxint.com](http://www.amaaxint.com)

---

**Instrument Details**

---

Needle Holder  
Wangenstein, Tungsten  
Carbide

Incorporating distinctive  
Tungsten Carbide jaws  
and gold bows.

---

**Stock Code**

---

14/1805/1 - 30cm  
14/1805/2 - 33cm  
14/1805/3 - 36cm

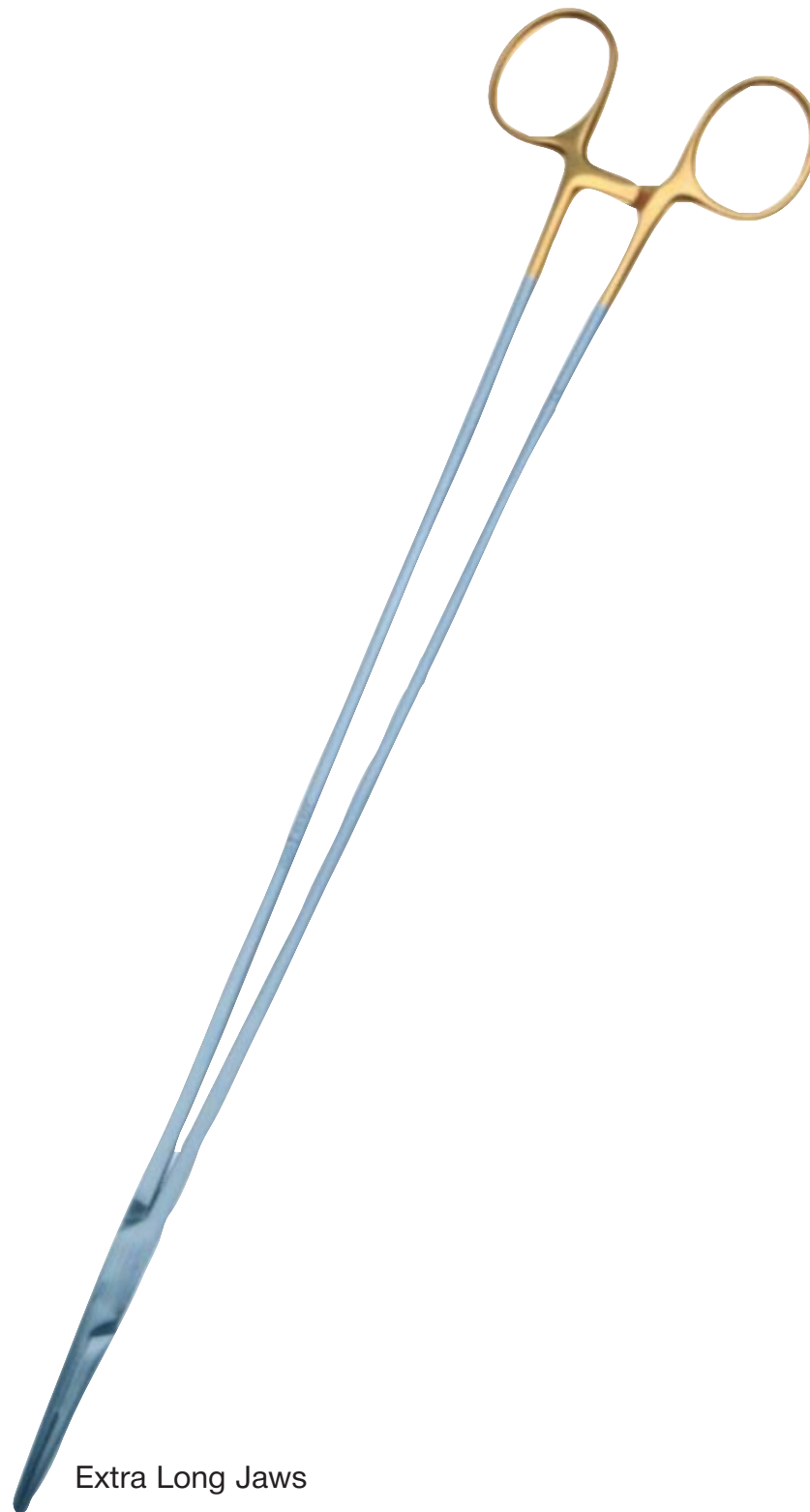

Extra Long Jaws

# Colo-Rectal / Intestinal Surgery

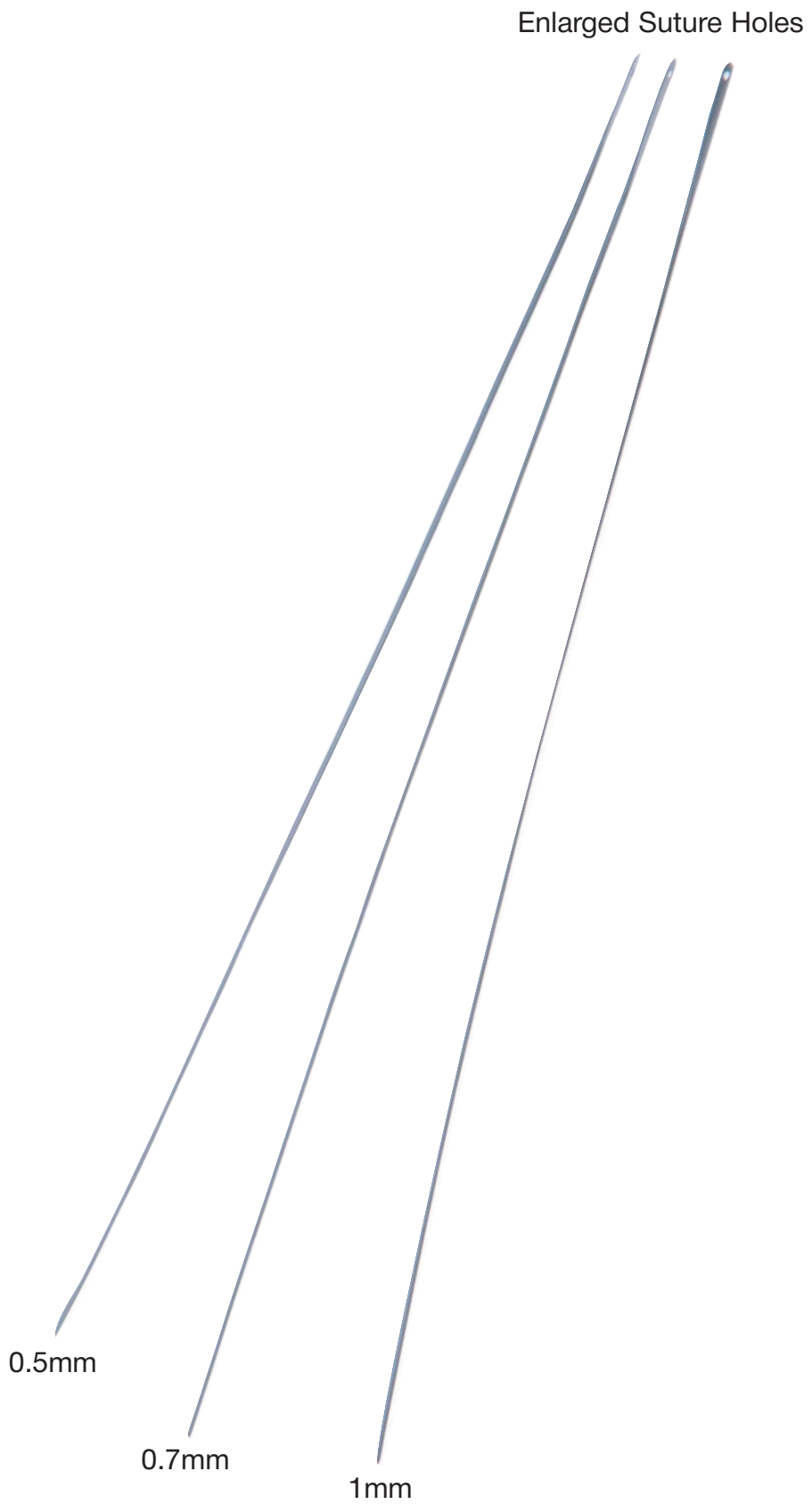

## Instrument Details

Probe  
Anal

Set of three stainless  
steel probes.

## Stock Code

18/0059 - Set of 3 15cm

**Instrument Details**

Probe  
Lockhart Mummery

These probes are now available with enlarged suture holes.

N.B. These probes are not malleable.

**Stock Code**

- 18/1697/5 - Set of 4
- 18/1697/1 - Straight, 18cm
- 18/1697/2 - Angled, 18cm
- 18/1697/3 - 90° angle, 18cm
- 18/1697/4 - Cvd retrograde, 18cm

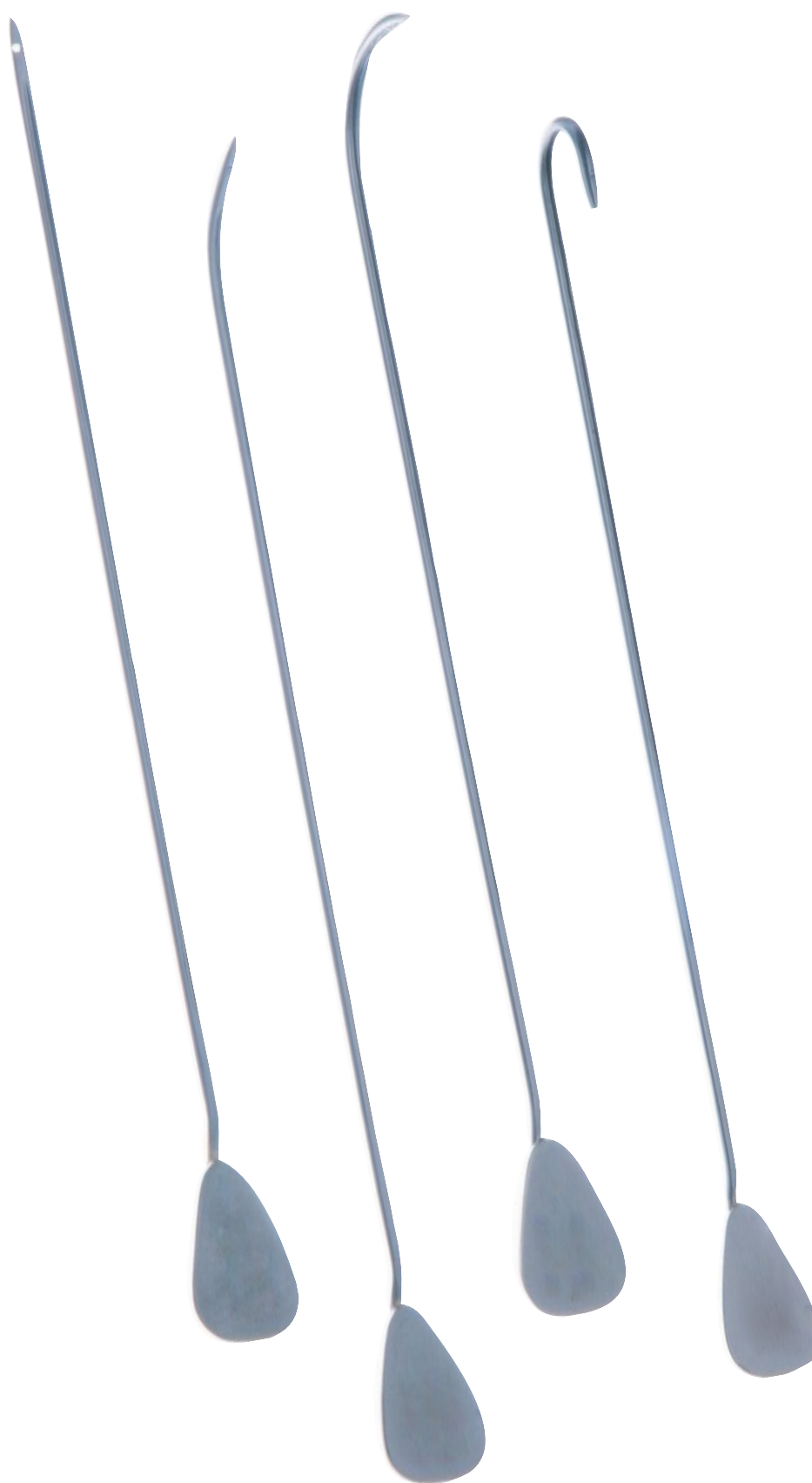

# Colo-Rectal / Intestinal Surgery



## Instrument Details

Cautery  
Coagulation Probe

This ball electrode is ideal for the cauterising of high tumours where access is difficult.

## Stock Code

25/1192 - 40cm

**Instrument Details**

Cautery  
Diathermy Angled  
Dissecting Forcep

This instrument is  
available in different  
lengths for safe  
diathermy procedures.

**Stock Code**

25/6003/23 - 30cm  
Serrated Angled

25/6003/24 - 32.5cm  
Serrated Angled

25/6003/25 - 36cm  
Serrated Angled

25/6003/26 - 38cm  
Serrated Angled

25/6003/27 - 30cm  
1:2 Angled

25/6003/28 - 32.5cm  
1:2 Angled

25/6003/29 - 36cm  
1:2 Angled

25/6003/30 - 38cm  
1:2 Angled



# Colo-Rectal / Intestinal Surgery

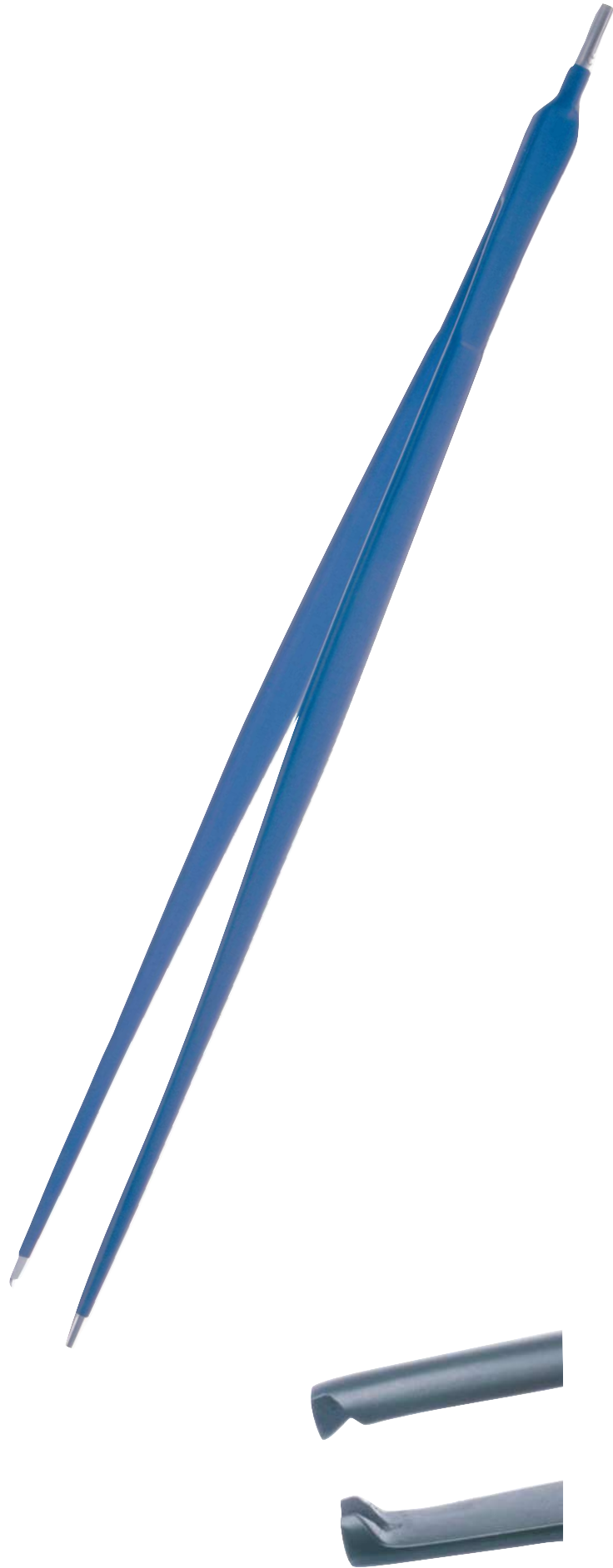

## Instrument Details

Cautery  
Forcep  
Diathermy Dissecting  
1:2

This instrument is available in different lengths for safe diathermy procedures. Jaws can be serrated or toothed.

## Stock Code

25/6003/19 - 30cm 1:2  
25/6003/20 - 32.5cm 1:2  
25/6003/21 - 36cm 1:2  
25/6003/22 - 38cm 1:2

25/6003/8 - 30cm Serrated  
25/6003/9 - 32.5cm Serrated  
25/6003/10 - 36cm Serrated  
25/6003/11 - 38cm Serrated

**Instrument Details**

Cautery  
DeBakey  
Diathermy Dissecting  
Forcep

This instrument is  
available in different  
lengths for safe  
diathermy procedures.

**Stock Code**

25/6003/31 - 30cm  
25/6003/32 - 32.5cm  
25/6003/33 - 36cm  
25/6003/34 - 38cm



DeBakey Jaw



# Colo-Rectal / Intestinal Surgery

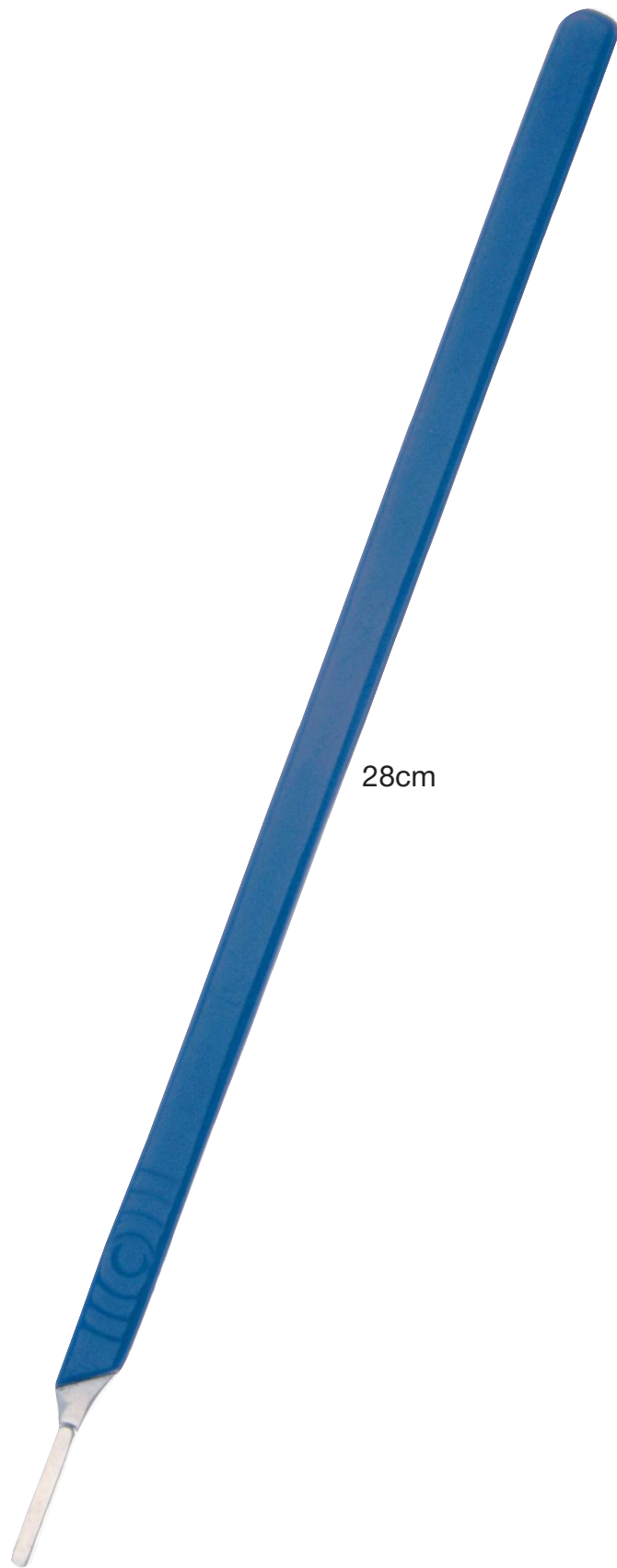

## Instrument Details

Cautery  
Insulated Scalpel  
Handle

This scalpel handle is  
extra long.

## Stock Code

Insulated  
29/0001/3 - 28cm No 3  
29/0002/3 - 28cm No 4

**Instrument Details**

Cautery  
Insulated Monopolar  
Scalpel Handle

This extra long insulated  
handle is perfect for  
Monopolar cautery  
dissection of the rectum.

**Stock Code**

25/0001/3 - 28cm No3

25/0002/3 - 28cm No4

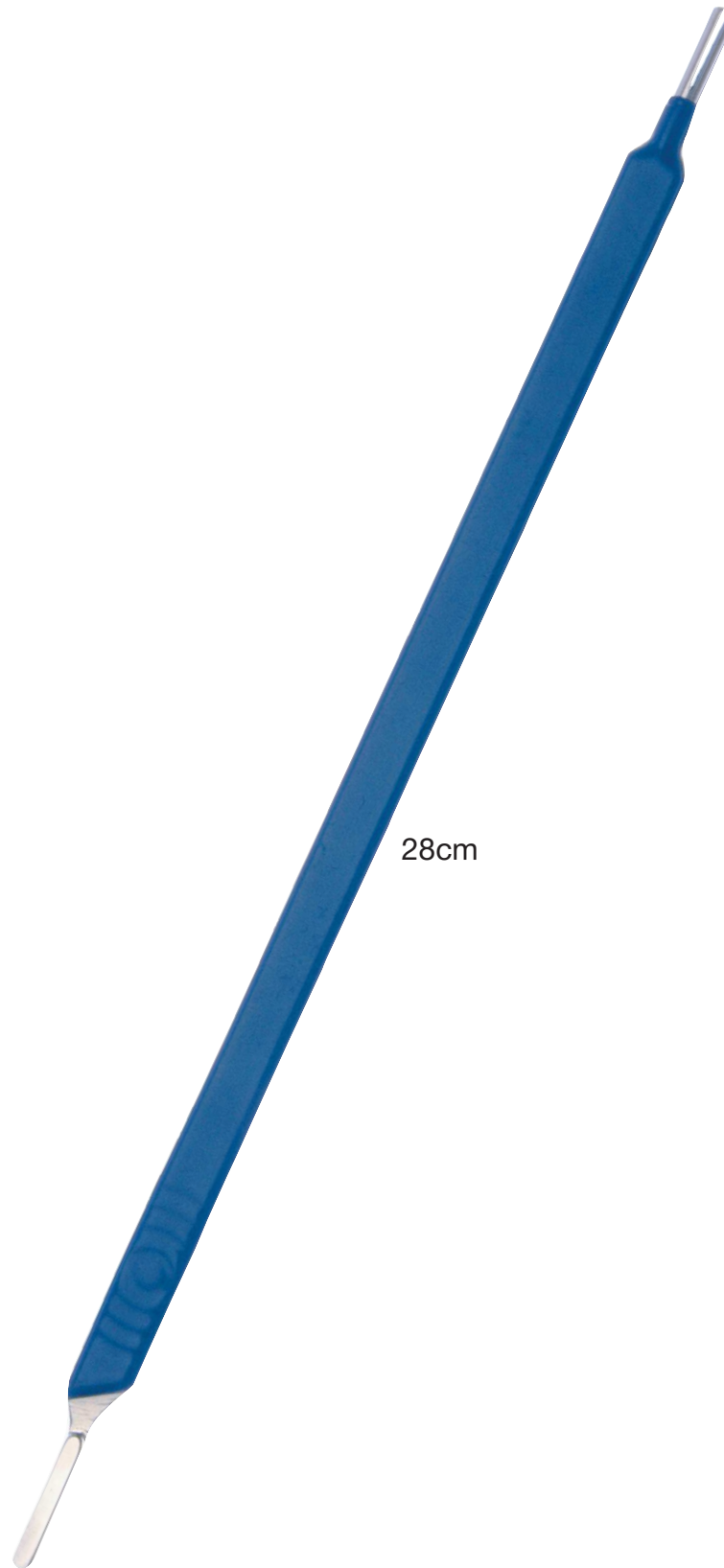

28cm

# Colo-Rectal / Intestinal Surgery



## Instrument Details

Cautery  
Turner Warwick  
MonoPolar Diathermy  
Scissor

This popular cautery scissor features extra length with a fully insulated shank. Also available in a Surecut pattern for excellent cutting action.

## Stock Code

25/6045/1 - 18cm Str  
25/6045/2 - 21.5cm Str  
25/6045/3 - 24cm Str  
25/6045/4 - 18cm Cvd  
25/6045/5 - 21.5cm Cvd  
25/6045/6 - 24cm Cvd  
25/6045/7 - 30cm Str  
25/6045/8 - 30cm Cvd

**Instrument Details**

Ligator  
Combined Suction

Allows precise  
haemorrhoid banding  
aided by suction.

Reuseable.

**Stock Code**

18/1691 - 19.5cm

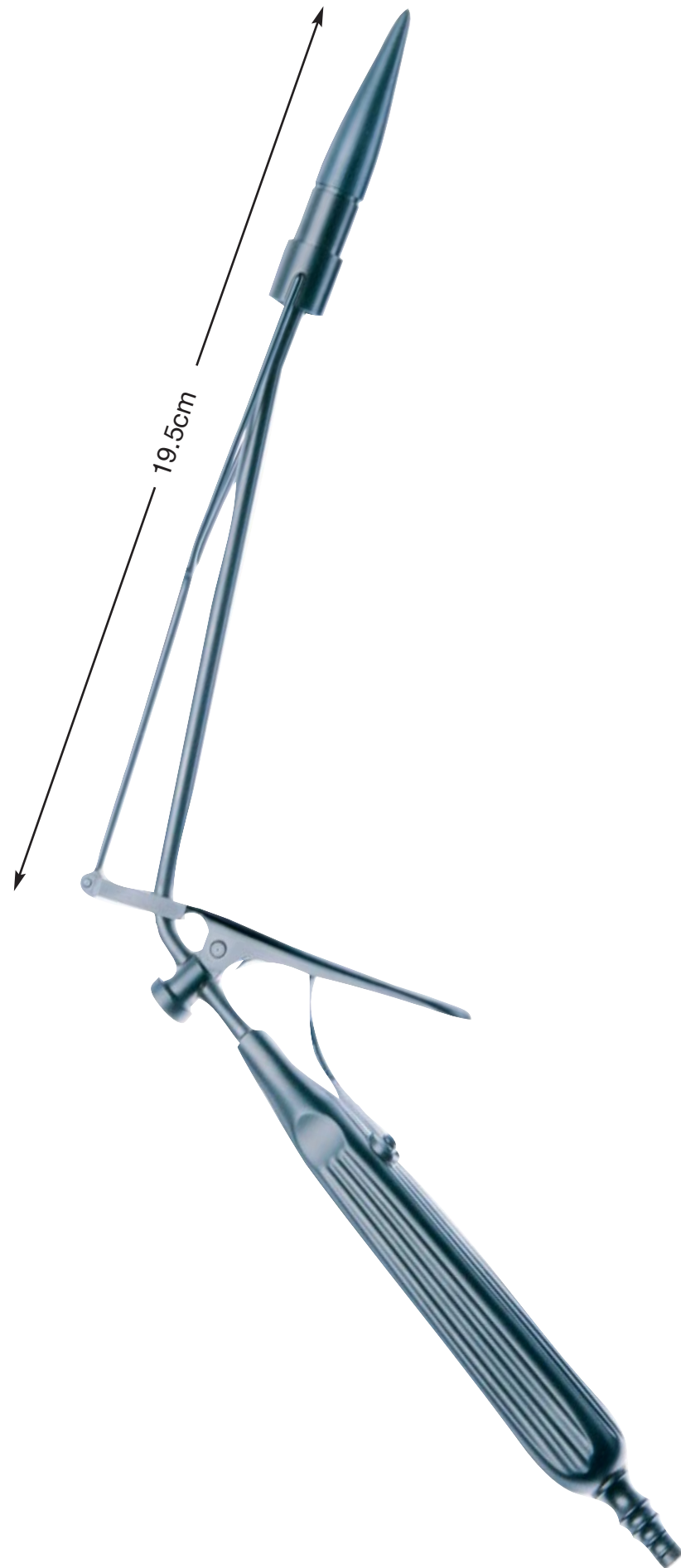

# Colo-Rectal / Intestinal Surgery

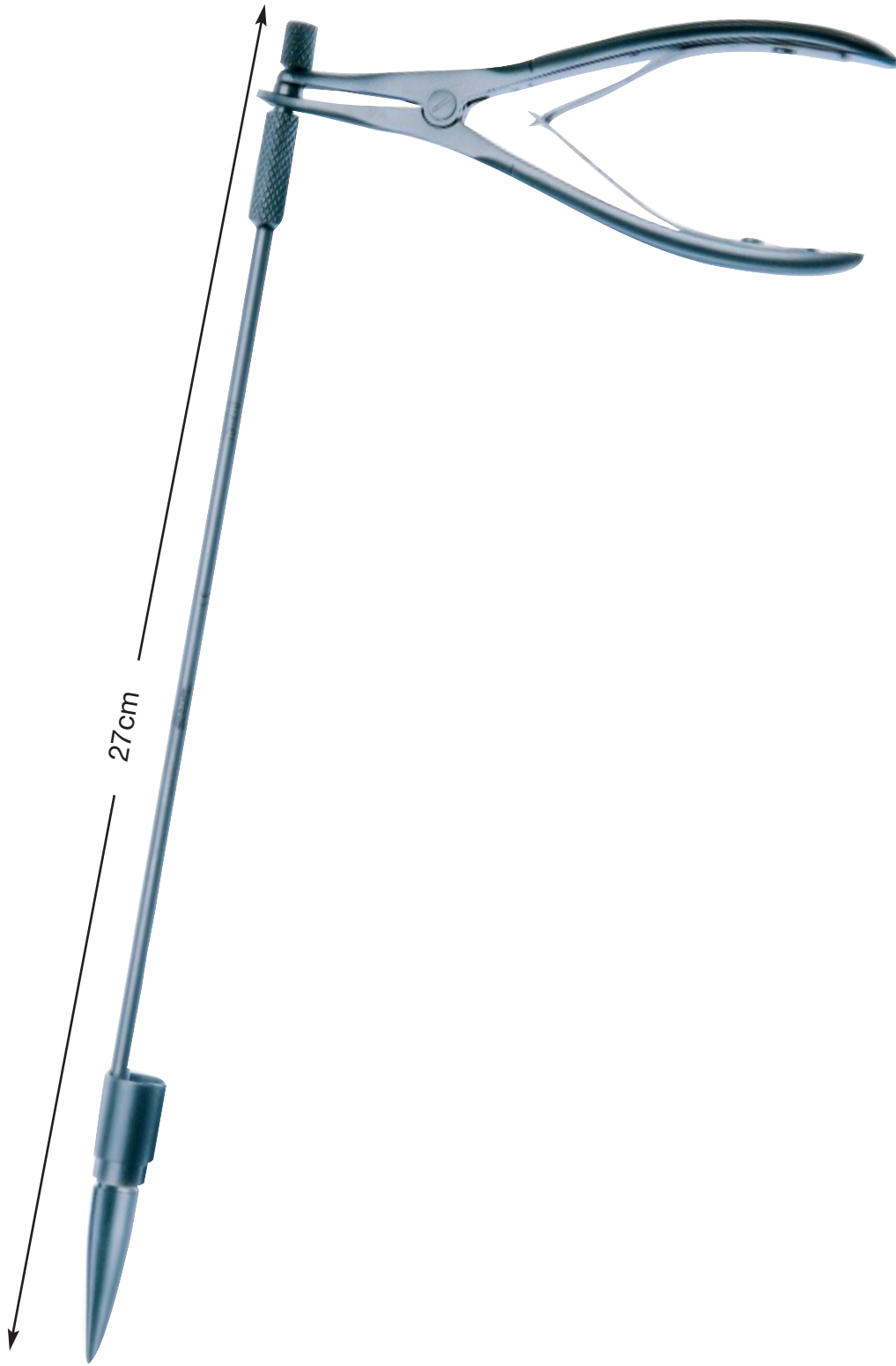

## Instrument Details

Ligator  
McGivney

Supplied with conical  
loader and 100 bands.

Reusable.

## Stock Code

18/1210 - 27cm

---

**Instrument Details**

---

Ligator  
St. Marks Simple Pattern

With conical loader.

Reuseable

---

**Stock Code**

---

18/1699 - 26.8mm



# Colo-Rectal / Intestinal Surgery

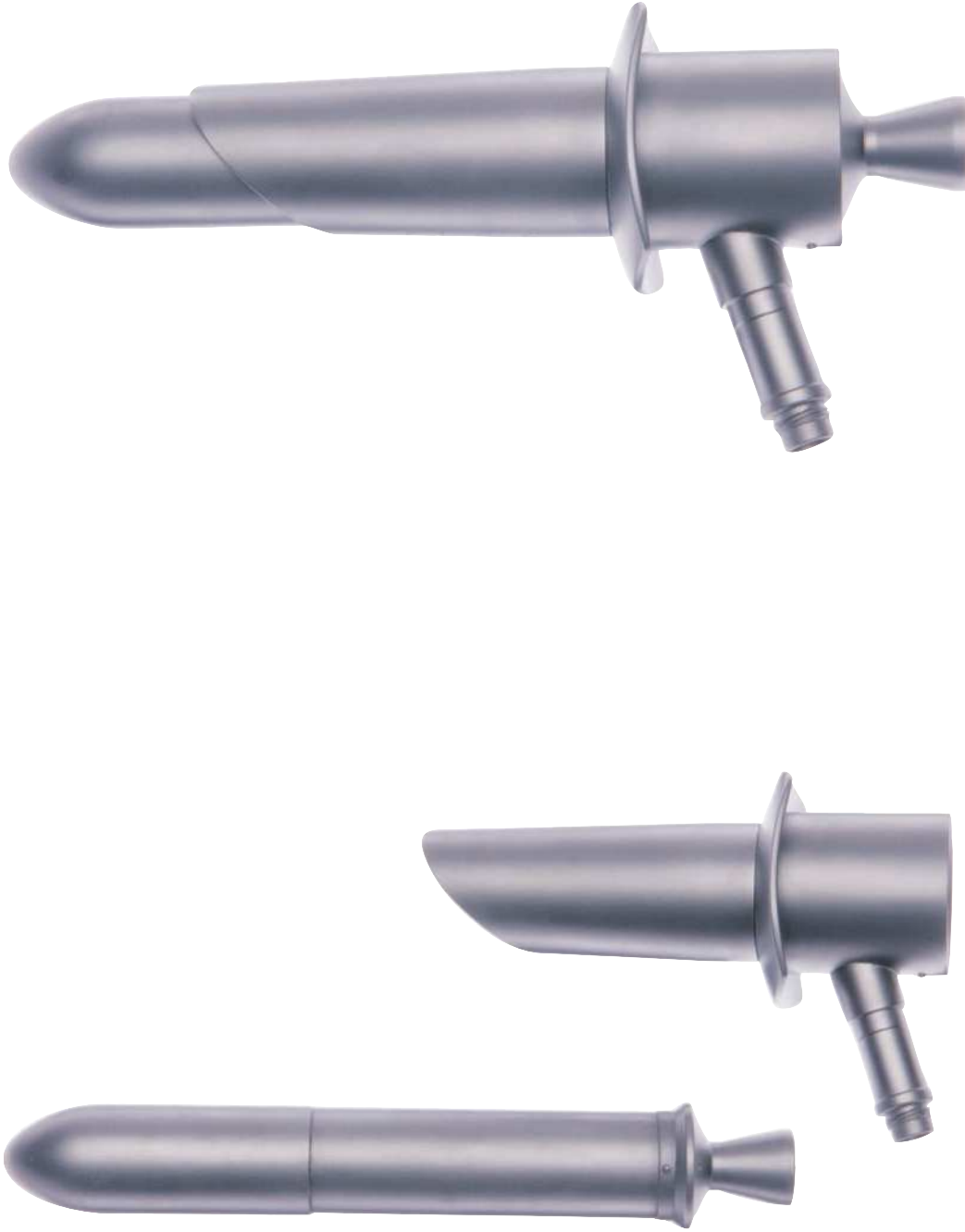

## Instrument Details

Speculum  
Anuscope

This instrument incorporates a fibre light allowing greater illumination during rectal diagnostics.

## Stock Code

18/4607

**Instrument Details**

Speculum  
Bi Valve

This three blade retractor offers maximum rectal examination with the aid of a ratchet and optional fibre light.



**Stock Code**

18/4608 - 95mm  
without fibre light

18/4608/1 - 95mm  
with fibre light



# Colo-Rectal / Intestinal Surgery



## Instrument Details

Speculum  
Eisenhammer  
3 Blade Rectal

This Eisenhammer has an added third blade enabling the surgeon to achieve maximum anal retraction. Available with or without fibre light system.

## Stock Code

18/4026/6 - 115mm  
without fibre light

18/4026/8 - 115mm  
with fibre light  
attachment

18/4026/7 - 70mm  
without fibre light

18/4026/9 - 70mm  
with fibre light  
attachment

**Instrument Details**

Speculum  
Eisenhammer  
with Fibre Light  
& Ratchet

This Speculum is designed for optimum anal retraction with a fast cam rack control. The speculum has a none reflective finish.

**Stock Code**

18/4026/5  
115mm beak with ratchet  
and fibre light

18/4026/3  
70mm beak with ratchet  
and fibre light



# Colo-Rectal / Intestinal Surgery



**AMAAX** INTERNATIONAL

## Instrument Details

Speculum  
Eisenhammer  
with Ratchet

Also available with  
optional fibrelight.

## Stock Code

18/4026/4 - 115mm beak

18/4026/1 - 70mm beak

[www.amaaxint.com](http://www.amaaxint.com)

**Instrument Details**

Speculum  
Farans Operating

Incorporating deep lateral  
blades and cam rack  
adjuster.

130mm lateral blades



**Stock Code**

18/4027 - 130mm

18/4027/1 - 130mm  
with fibre light

18/4027/2 - 130mm  
with 3rd blade

# Colo-Rectal / Intestinal Surgery



## Instrument Details

Speculum  
Haemorrhoidectomy

This speculum has been designed to aid haemorrhoid banding. The Haemorrhoid is easily located and isolated due to the fenestration. Available with fibre light.

Designed in conjunction with Miss K R L Brown MS FRCS, Consultant Surgeon, The Luton and Dunstable Hospital, England.

## Stock Code

18/4609 - 90mm

18/4609/1 - 90mm  
with fibre light

**Instrument Details**

Speculum  
McEverdy  
Proctoscope

The McEverdy Proctoscope has a sliding top which can be removed when inserted enabling examination of the anal wall. Available with fibre light for superior illumination.

**Stock Code**

18/4610 - 90mm  
with fibre light

# Colo-Rectal / Intestinal Surgery



## Instrument Details

Speculum  
Naunton Morgan

This Proctoscope is available in three sizes with fitting for fibre light.

## Stock Code

18/1201/1 - Child

18/1201/2 - Adolescent

18/1201/3 - Adult

18/0183/2 - Fibre optic stem for proctoscope

Illustration shows fibre light fitted.

**Instrument Details**

Speculum  
Pratts Rectal

With screw adjustment.

**Stock Code**

18/0151 - 95mm



95mm

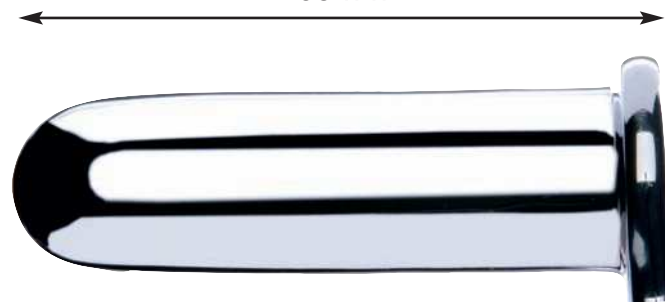

# Colo-Rectal / Intestinal Surgery



## Instrument Details

Speculum  
Roschke Rectal

A very fine rectal Speculum which is ideal for use in Paediatric examination or a restricted anal canal. Incorporates an adjustable wheel mechanism.

## Stock Code

18/4400 - 75mm

**Instrument Details**

Speculum  
Sims Rectal

This Speculum has a double fenestrated blade for rectal wall examination. Includes adjustable screw mechanism.



**Stock Code**

18/4611 - 90mm

# Colo-Rectal / Intestinal Surgery



## Instrument Details

Retractor  
Anterior Cheesegrater

This retractor is designed specifically to achieve maximum retraction during Anterior Pelvic Resection. The unique blade design has a dual function. 1. A serrated curved inner distal tip for optimum tissue control. 2. A flat constructed blade to allow greater dispersion of the abdominal wall tissue. The anatomically designed handle gives greater comfort and control.

## Stock Code

18/1830/1 - 200x40mm  
18/1830/2 - 200x50mm  
18/1830/3 - 200x65mm  
Plain

18/1830/4 - 200x40mm  
18/1830/5 - 200x50mm  
18/1830/6 - 200x65mm  
With fibre light.

18/1830/7 - 200x40mm  
18/1830/8 - 200x50mm  
18/1830/9 - 200x65mm  
With fibre light and  
smoke evacuation tube.

**Instrument Details**

Retractor  
Balfour

This set includes frame,  
two centre blades and  
four sets of snap on  
lateral blades ideal for  
abdominal procedures.

Lateral Blade Sizes

- 1. 70mm
- 2. 90mm
- 3. 115mm
- 4. 160mm

**Stock Code**

14/2020/6  
Full Set



## Instrument Details

Retractor

Anterior

This retractor effectively replaces the second assistant during A.P. procedures, aiding the surgeon to achieve complete bladder retraction with maximum flexibility.

This device has been designed and developed in conjunction with Mr A.J. Shorhouse BSc MS FRCS of the Royal Hallamshire Hospital, Sheffield.

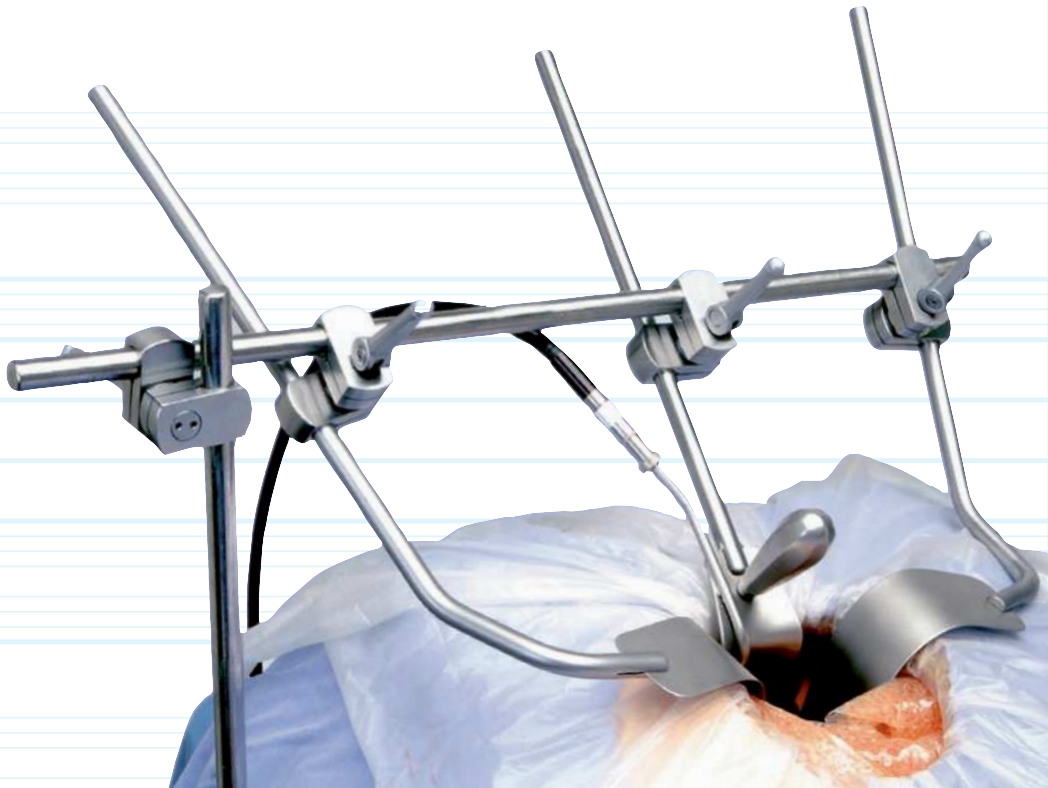

## Stock Code

18/4028/1 - Blade 19cm x 60mm  
18/4028/2 - Blade 19cm x 50mm  
18/4028/3 - Blade 26cm x 60mm  
18/4028/4 - Blade 26cm x 50mm

18/4028/5 - Blade 19cm x 60mm  
18/4028/6 - Blade 19cm x 50mm  
18/4028/7 - Blade 26cm x 60mm  
18/4028/8 - Blade 26cm x 50mm  
With fibrelight

18/4028/9 - Blade 19cm x 60mm  
18/4028/10 - Blade 19cm x 50mm  
18/4028/11 - Blade 26cm x 60mm  
18/4028/12 - Blade 26cm x 50mm  
With fibrelight & suction

18/4028/13 - Malleable swivel lateral blade, left  
18/4028/14 - Malleable swivel lateral blade, right

18/4028/15 - Angled flat blade 30°  
18/4028/16 - Angled flat blade 30° with fibrelight  
18/4028/17 - Angled flat blade 30°  
with fibrelight and suction

18/4028/18 - Angled flat blade 45°  
18/4028/19 - Angled flat blade 45° with fibrelight  
18/4028/20 - Angled flat blade 45°  
with fibrelight and suction

18/4028/21 - Table clamp  
18/4028/22 - Cam lock 16mm x 16mm  
for use with vertical pole

18/4028/23 - Vertical pole  
18/4028/24 - Horizontal pole  
18/4028/25 - Cam lock 16mm x 12mm  
for use with horizontal pole

18/4028/26 - Horizontal offset pole

**Instrument Details**

Retractor  
Fan Blade

This malleable blade retractor has been designed to be used in conjunction with the Balfour and Golligher retractors. Fully adjustable blades operated by a simple locking screw. Aids retraction of the small bowel.

Note: This fan blade is also available to fit the Turner Warwick Retractor.

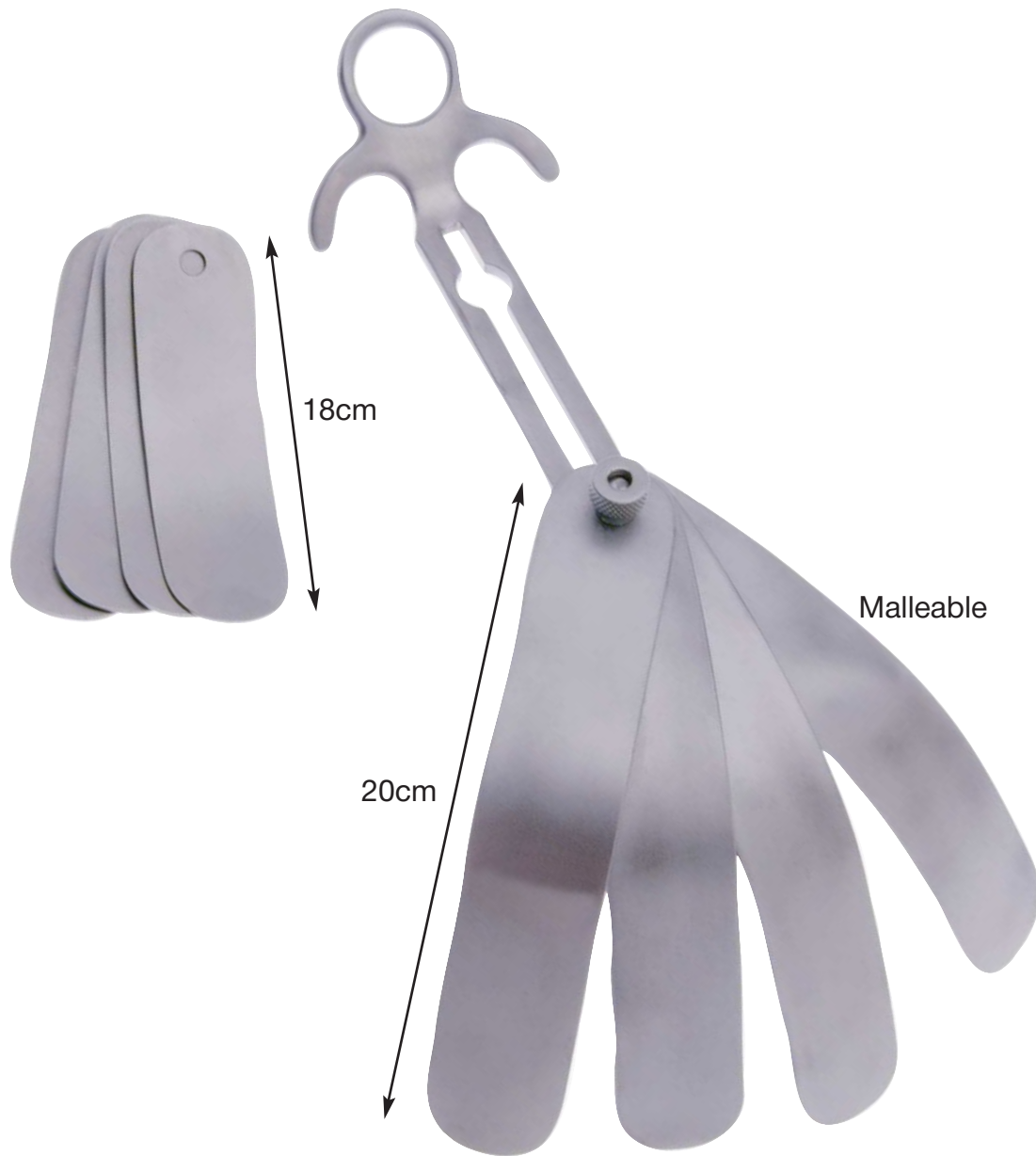

**Stock Code**

14/2024  
includes both sets of  
blades illustrated.



# Colo-Rectal / Intestinal Surgery



## Instrument Details

Retractor  
Fanzler

The Fanzler speculum is designed to be used in conjunction with the staple gun. Can also be used for trans anal repair. Available in different lengths on request.

## Stock Code

18/3110/1 - 70mm

18/3110 - 50mm

**Instrument Details**

Retractor  
Gelpi

This self-retaining retractor, used as a pair, is ideal for perineal excision. Available with a non-reflective finish.

**Stock Code**

20/2023 - 16.5cm



# Colo-Rectal / Intestinal Surgery



## Instrument Details

Retractor  
Golligher

This retractor has two centre blades of different depths and two sets of lateral blades with locking screws. The Golligher retractor has a non reflective finish.

## Stock Code

14/3054 - Full Set

**Instrument Details**

Retractor  
Hand Extension 1,2 & 3

This malleable retractor easily fits into the hand, giving an extended surface area for the surgeon or assistant. The hand extension is ideal for deep abdominal procedures.

These hand extensions can be manufactured to the surgeons own requirement and size.

**Stock Code**

- 1. 18/4612/1 - 20.5x11cm
- 2. 18/4612/2 - 20.5x10.5cm
- 3. 18/4612/3 - 22.5x9.5cm

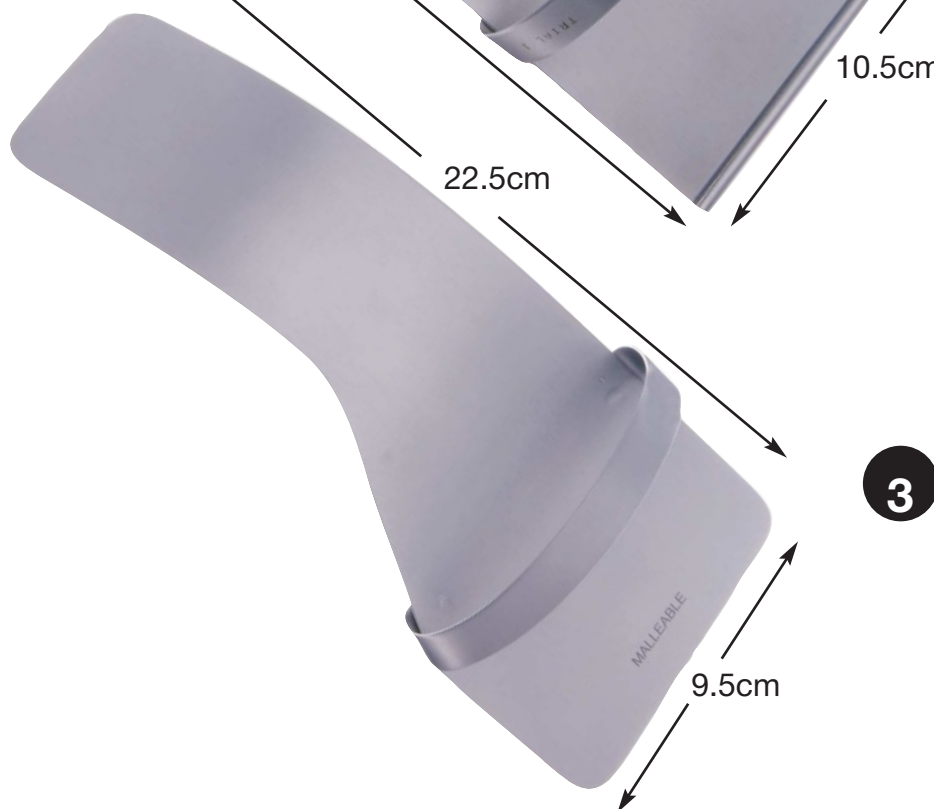
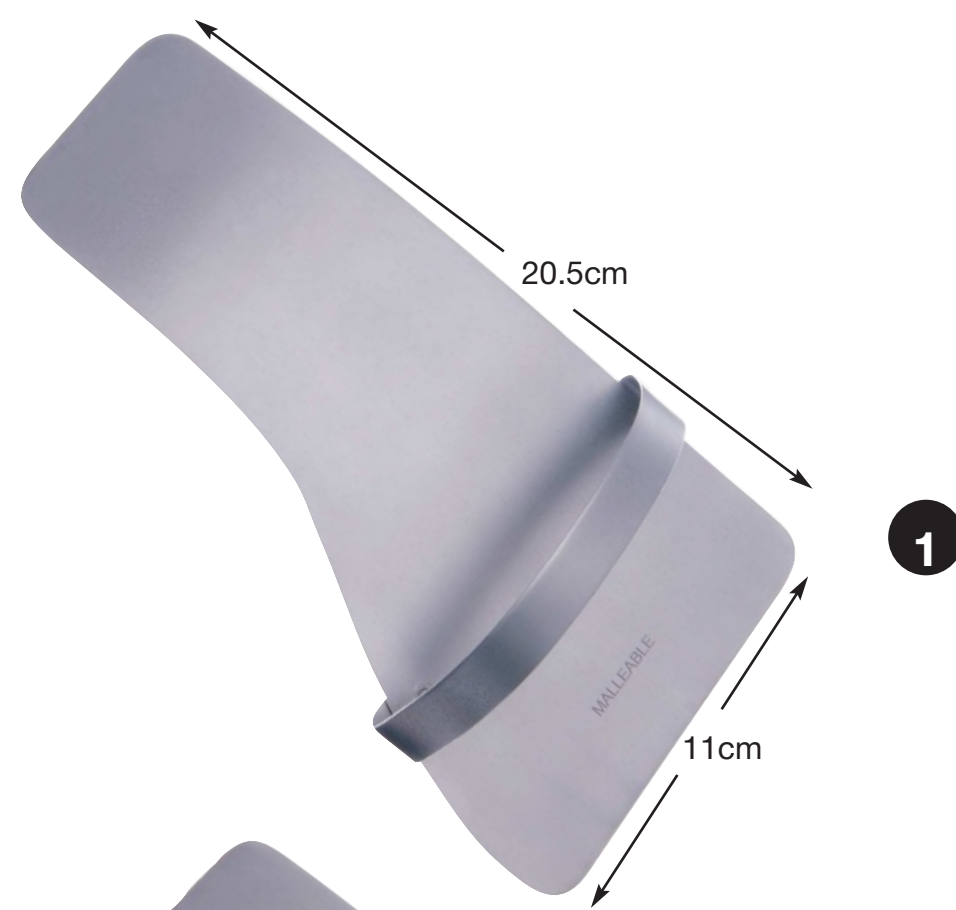

# Colo-Rectal / Intestinal Surgery



## Instrument Details

Retractor  
Hill Ferguson

For optimum retraction.

## Stock Code

18/1250 - 25mmx90mm  
18/1250/1 - 30mmx100mm  
18/1250/2 - 40mmx110mm  
without fibre light

18/1250/3 - 25mmx90mm  
18/1250/4 - 30mmx100mm  
18/1250/5 - 40mmx110mm  
with fibre light

**Instrument Details**

Retractor  
Kocher

A deep lateral retractor featuring a narrow blade and detachable fibre light.

**Stock Code**

18/1993 - 10cm x 20mm  
18/1993/1 - 10cm x 30mm  
18/1993/2 - 10cm x 40mm  
18/1993/3 - 14cm x 20mm  
18/1993/4 - 14cm x 30mm  
18/1993/5 - 14cm x 40mm  
18/1993/6 - 18cm x 20mm  
18/1993/7 - 18cm x 30mm  
18/1993/8 - 18cm x 40mm



# Colo-Rectal / Intestinal Surgery

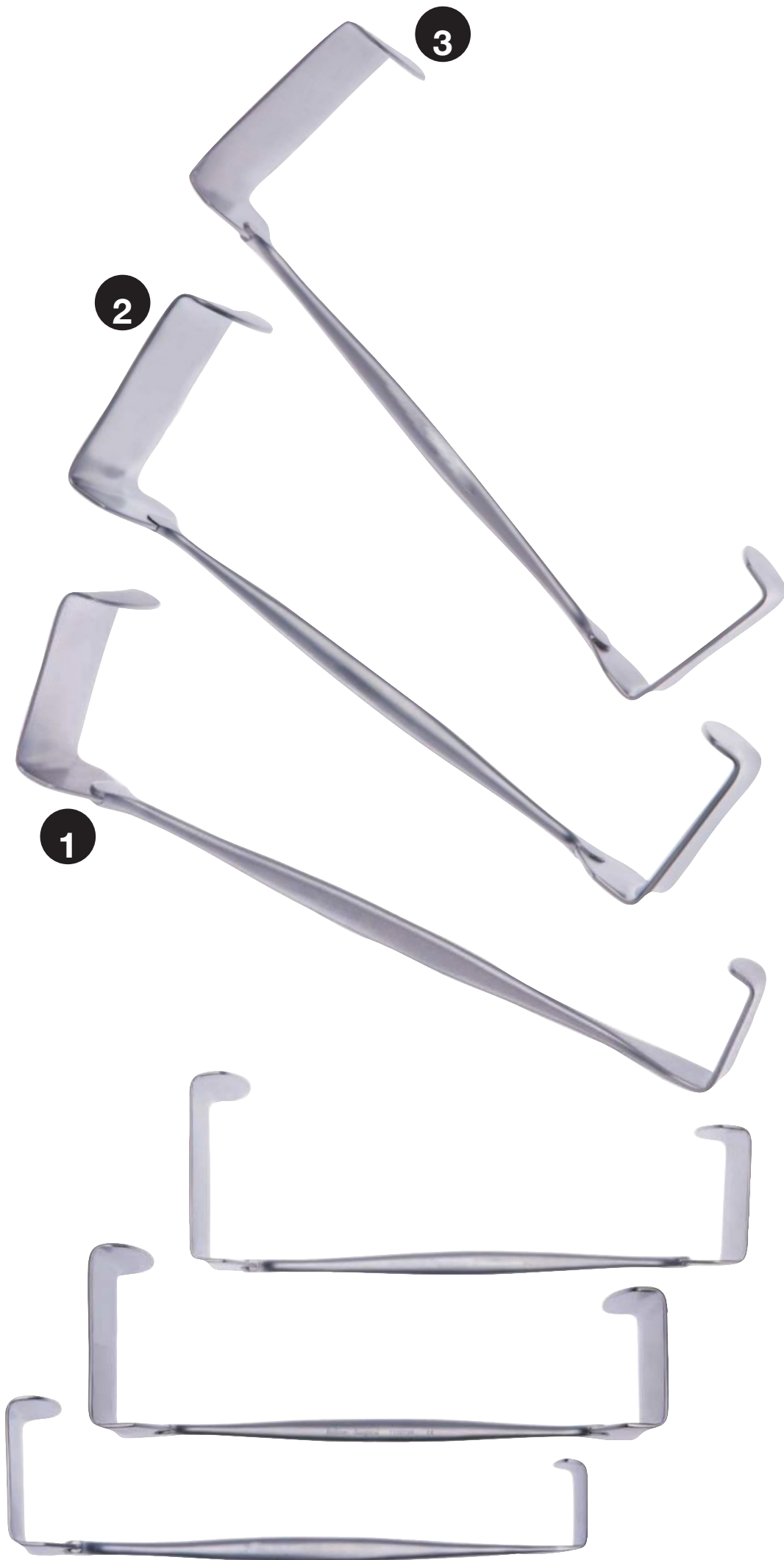

## Instrument Details

Retractor  
Morris Double Ended

## Stock Code

- 1.** 14/2013/4  
20mm x 40mm Blades &  
40mm x 60mm Blades
- 2.** 14/2013/6  
50mm x 60mm Blades &  
60mm x 80mm Blades
- 3.** 14/2013/5  
40mm x 60mm Blades &  
60mm x 80mm Blades

**Instrument Details**

Retractor  
Morris Single End

Available with fibre light  
system on request.



**Stock Code**

**1.** 14/2013/3  
60mm x 80mm

**2.** 14/2013/7  
70mm x 50mm

# Colo-Rectal / Intestinal Surgery



## Instrument Details

Retractor  
Parkes Lateral Screw

Incorporating a central  
screw adjuster with  
swivel blades.

## Stock Code

18/1209/2 - 90mm  
Swivel blades

**Instrument Details**

Retractor  
Parkes Anal Combination

This retractor has an additional fibre lit centre blade and two sets of interchangeable lateral blades.

**Stock Code**

- 18/1209/2 - 4 blades
- 18/1209 - 4 blades  
1 adjusting blade
- 18/1209/1 - 4 blades  
1 adjusting blade with  
fibre light as illustrated

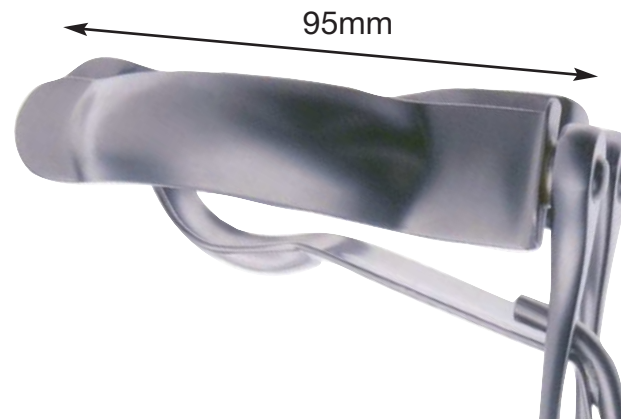

# Colo-Rectal / Intestinal Surgery



Non-insulated option illustrated.

Tissue grip.

## Instrument Details

Retractor  
Seedhouse

This retractor is designed for deep perineal sites. Featuring an anatomically designed handle. This retractor is available with a fibre light attachment.

## Stock Code

18/1261/1 - 17cm x 4cm  
18/1261/2 - 17cm x 5cm  
18/1261/3 - 17cm x 6.5cm  
Insulated

18/1261/4 - 17cm x 4cm  
18/1261/5 - 17cm x 5cm  
18/1261/6 - 17cm x 6.5cm  
Non-Insulated

**Instrument Details**

Retractor  
Seedhouse Angled

This retractor is designed for deep perineal sites. It also incorporates an anatomically designed handle and a non reflective finish. This retractor is available with an optional fibre light attachment.

**Stock Code**

18/1261/7 - 50mm x 21cm  
Non-Insulated

18/1261/8 - 50mm x 21cm  
Insulated



# Colo-Rectal / Intestinal Surgery



Insulated option illustrated.

## Instrument Details

Retractor  
Sheffield Pattern

This pair of retractors are ideal for lateral or for retraction and hernia procedures. The retractors illustrated have optional insulated blades.

## Stock Code

18/4613/1 - 95mm x 20mm  
18/4613/2 - 115mm x 35mm  
Insulated

18/4613/3 - 95mm x 20mm  
18/4613/4 - 115mm x 35mm  
Non-insulated

**Instrument Details**

Retractor  
St. Marks Perineal

With swivel blades and  
none reflective finish.

**Stock Code**

18/1696/1 - 55m x 30mm  
blades

18/1696 - 70mm x 50mm  
blades



Small option illustrated.

# Colo-Rectal / Intestinal Surgery

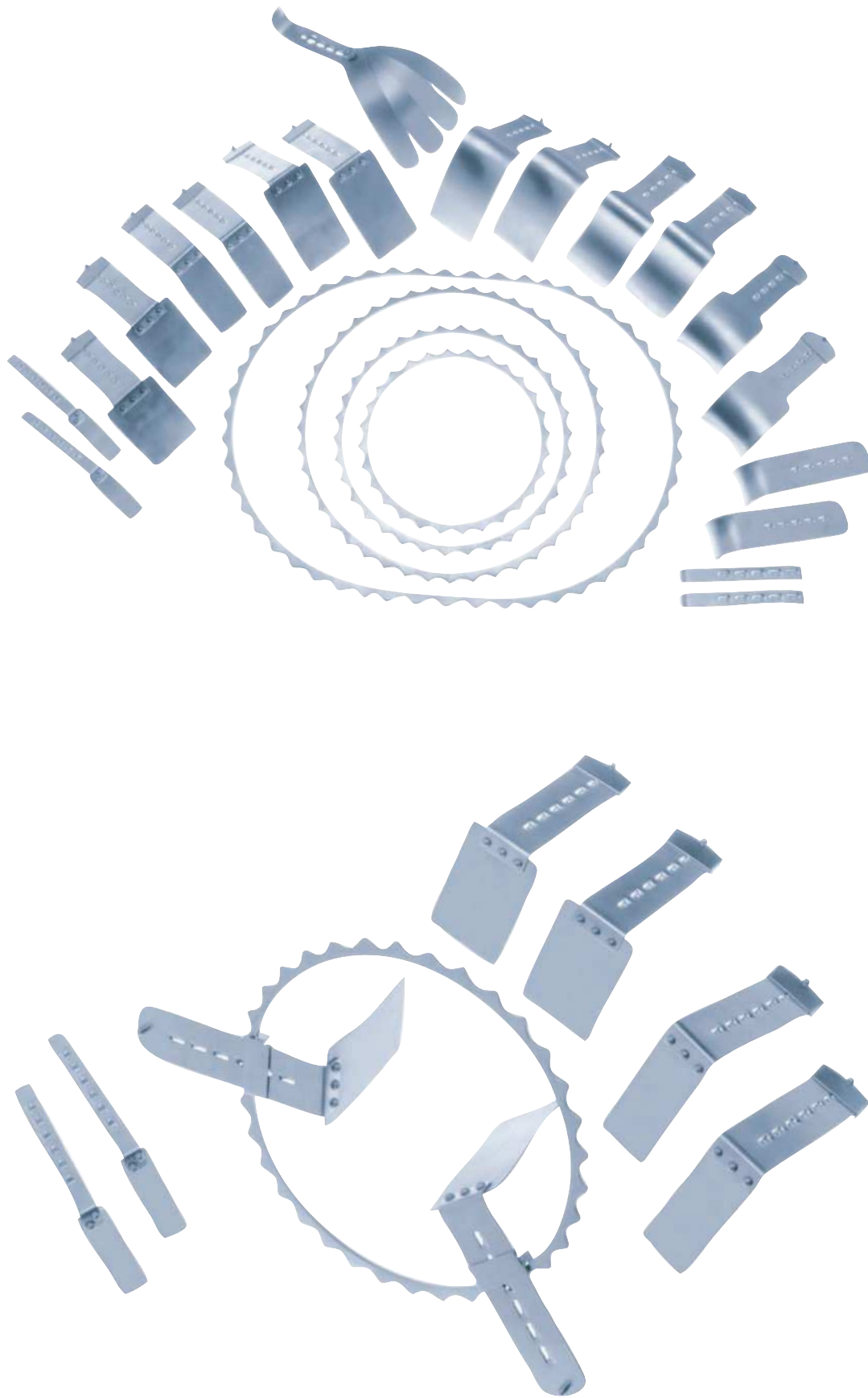

## Instrument Details

Retractor  
Turner Warwick Universal

With 19 Blades.

## Stock Code

**14/4710**  
**Complete Retractor**  
**Set comprises of**  
**4 rings & 19 blades**

### Malleable Blades

14/4710/1 x 2 7.5cm x 20mm  
14/4710/2 x 2 9cm x 60mm  
14/4710/9 x 2 10.9 x 40mm  
14/4710/3 x 2 11.5cm x 60mm

### Steel Blades

14/4710/4 x 2 10mm  
14/4710/5 x 2 40mm  
14/4710/6 x 2 60mm  
14/4710/7 x 2 60mm with lip  
14/4710/8 x 2 60mm with S shape

### Fan Blade

14/2024/1 x 1

### Rings

14/2024/9 x 1 20cm dia  
14/2024/10 x 1 25cm dia  
14/2024/11 x 1 32cm dia  
14/2024/12 x 1 oval 46cm x 35cm

**Instrument Details**

Retractor  
Turner Warwick Universal

Fan Blade attachment for  
retraction of small bowel.

Other blade sizes  
available on request.

Note: Fits Turner Warwick  
Retractor only.

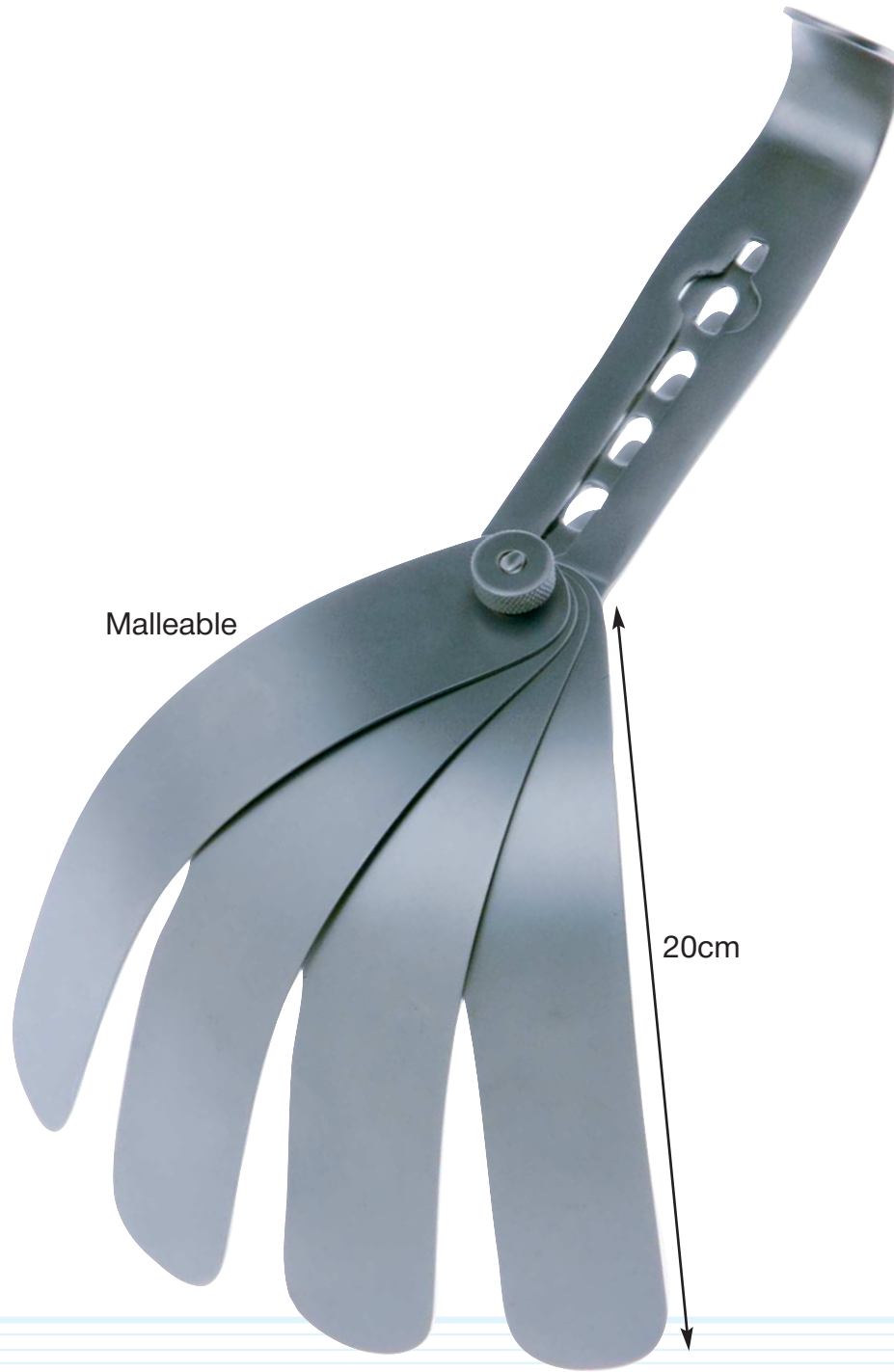

**Stock Code**

14/2024/1 - 20cm



# Colo-Rectal / Intestinal Surgery



## Instrument Details

Suction Tube  
Pooles Suction

These suction tubes are available in three lengths and with the option of insulation.

## Stock Code

23/0209/1 - 30cm  
23/0209/3 - 33cm  
23/0209/4 - 36cm  
Non-insulated

23/0209/2 - 30cm  
23/0209/5 - 33cm  
23/0209/6 - 36cm  
Insulated

**Instrument Details**

Suction Tube  
Yankeur Extra Long

Available double angled  
or single.

**Stock Code**

14/0213/3 - 39cm  
Double Angle

14/0213/2 - 39cm  
Single Angle



# Colo-Rectal / Intestinal Surgery



## Instrument Details

Light System  
Light Stem for  
Disposable Poole's  
Suction Tube

This clip on fibre light stem is designed to fit disposable suction tubes by a simple fitting. This re-useable fibre light stem is fully autoclavable and is invaluable when suction and light are both required. This stem is complete with triple fitting cable adaptor.

## Stock Code

18/1957 - 35cm

**Instrument Details**

Light System  
Light Stem for  
Disposable Yankeur  
Suction Tube

This clip on fibre light stem is designed to fit disposable suction tubes by a simple fitting. This re-useable fibre light stem is fully autoclavable and is invaluable when suction and light are both required. This stem is complete with triple fitting cable adaptor.

**Stock Code**

18/1957/1 - 32cm



# Colo-Rectal / Intestinal Surgery



## Instrument Details

Light System  
Light Stick Wand

This light stick incorporates a durable Tufnol handle with a fully insulated shaft, giving extra light where required.

This instrument also has a triple adaptor which will fit almost all light cables.

## Stock Code

18/0058/1 - 24cm shaft

**Instrument Details**

Set  
Sigmoidoscope  
Operating Set

Set comprises of:

- 2 x Cannulae
- 2 x Obturators
- 2 x Suction Tubes
- 1 x Sigmoidoscope Fibre  
Optic Attachment
- 1 x Attachment Eye Piece
- 1 x Suction Tube with  
detachable hand
- 1 x Sigmoidoscope  
Double Bellows

Case for holding  
complete kit.

**Stock Code**

18/1279 - Full Set



**Instrument Details**

Retractor  
St Marks Standard Blade

**Stock Code**

Hand Held

18/4500/1 - 19cm x 50mm

18/4500/2 - 19cm x 60mm

18/4500/3 - 26cm x 50mm

18/4500/4 - 26cm x 60mm

Interchangable

18/4500/5 - 19cm x 50mm

18/4500/6 - 19cm x 60mm

18/4500/7 - 26cm x 50mm

18/4500/8 - 26cm x 60mm



# Colo-Rectal / Intestinal Surgery



## Instrument Details

Retractor  
St Marks Parallel Blade

This range of retractors have the advantage of parallel blades which are ideal for deep lateral wall and perineal sites. This retractor is available in various sizes and also has the option of a starlight fibre light system.

## Stock Code

Hand Held

18/4521/1 - 19cm x 30mm  
18/4521/2 - 19cm x 40mm  
18/4521/3 - 19cm x 50mm  
18/4521/4 - 19cm x 60mm  
18/4521/5 - 26cm x 30mm  
18/4521/6 - 26cm x 40mm  
18/4521/7 - 26cm x 50mm  
18/4521/8 - 26cm x 60mm

Interchangeable

18/4521/9 - 19cm x 30mm  
18/4521/10 - 19cm x 40mm  
18/4521/11 - 19cm x 50mm  
18/4521/12 - 19cm x 60mm  
18/4521/13 - 26cm x 30mm  
18/4521/14 - 26cm x 40mm  
18/4521/15 - 26cm x 50mm  
18/4521/16 - 26cm x 60mm

---

**Instrument Details**

---

Retractor  
St Marks Flat Blade  
30° angle

An alternative to the conventional St Marks, this Flat Blade retractor offers enhanced bladder and prostate elevation. This retractor comes with a choice of two angled distal tips available with the superior starlight fibre optic system. This retractor is considered a major step forward for deep abdominal procedures.

---

**Stock Code**

---

Hand Held  
18/4510/1 - 19cm x 50mm  
18/4510/2 - 19cm x 60mm  
18/4510/3 - 26cm x 50mm  
18/4510/4 - 26cm x 60mm

Interchangeable  
18/4510/5 - 19cm x 50mm  
18/4510/6 - 19cm x 60mm  
18/4510/7 - 26cm x 50mm  
18/4510/8 - 26cm x 60mm



# Colo-Rectal / Intestinal Surgery



## Instrument Details

Retractor  
St Marks Flat Blade  
45° Angle

An alternative to the conventional St Marks, this Flat Blade retractor offers enhanced bladder and prostate elevation.

## Stock Code

Hand Held

18/4530/1 - 19cm x 50mm  
18/4530/2 - 19cm x 60mm  
18/4530/3 - 26cm x 50mm  
18/4530/4 - 26cm x 60mm

Interchangeable

18/4530/5 - 19cm x 50mm  
18/4530/6 - 19cm x 60mm  
18/4530/7 - 26cm x 50mm  
18/4530/8 - 26cm x 60mm

---

**Instrument Details**

---

Retractor  
St Marks Lightweight

This St Marks offers maximum retraction with double or single fenestrated blades. It has a none reflective finish.

---

**Stock Code**

---

Hand Held

18/4515/1 - 19cm x 50mm  
18/4515/2 - 19cm x 60mm  
18/4515/3 - 26cm x 50mm  
18/4515/4 - 26cm x 60mm

Interchangeable

18/4515/5 - 19cm x 50mm  
18/4515/6 - 19cm x 60mm  
18/4515/7 - 26cm x 50mm  
18/4515/8 - 26cm x 60mm



# Colo-Rectal / Intestinal Surgery



**Components not compatible with this retractor  
due to the malleable blade.**

## Instrument Details

Retractor  
St Marks Malleable

This retractor has the benefit of a malleable blade. That can be adjusted by the surgeon to the required angle.

## Stock Code

Hand Held

18/4535/1 - 19cm x 50mm

18/4535/2 - 19cm x 60mm

18/4535/3 - 26cm x 50mm

18/4535/4 - 26cm x 60mm

Interchangeable

18/4535/5 - 19cm x 50mm

18/4535/6 - 19cm x 60mm

18/4535/7 - 26cm x 50mm

18/4535/8 - 26cm x 60mm

---

**Instrument Details**

---

Retractor  
St Marks Deep Curve

This St Marks retractor has been modified by means of an extra deep curvature. This allows greater accessibility and elevation.

---

**Stock Code**

---

Hand Held

18/4520/1 - 19cm x 50mm  
18/4520/2 - 19cm x 60mm  
18/4520/3 - 26cm x 50mm  
18/4520/4 - 26cm x 60mm

Interchangeable

18/4520/5 - 19cm x 50mm  
18/4520/6 - 19cm x 60mm  
18/4520/7 - 26cm x 50mm  
18/4520/8 - 26cm x 60mm



# Colo-Rectal / Intestinal Surgery



**AMAAX** INTERNATIONAL

## Instrument Details

Retractor  
St Marks Mid Anterior  
Range

This medium range St Marks features a 90° angle and a concave blade.

## Stock Code

Hand Held  
18/4540/1 - 12cm x 50mm  
18/4540/2 - 12cm x 60mm

Interchangeable  
18/4540/3 - 12cm x 50mm  
18/4540/4 - 12cm x 60mm

[www.amaaxint.com](http://www.amaaxint.com)

---

**Instrument Details**

---

Retractor  
St Marks Interchangeable

This unique design has an interchangeable feature whereby an assortment of blades can be used. This system operates by a simple locking screw. All blade lengths and widths are available on request.



---

**Stock Code**

---

18/4505