

# 16

**Magen, Darm, Rektum**

---

**Stomach, Intestines, Rectum**

---

**Estomac, Intestins, Rectum**

---

**Estómago, Intestinos, Recto**

---

**Stomaco, Intestini, Retto**

---

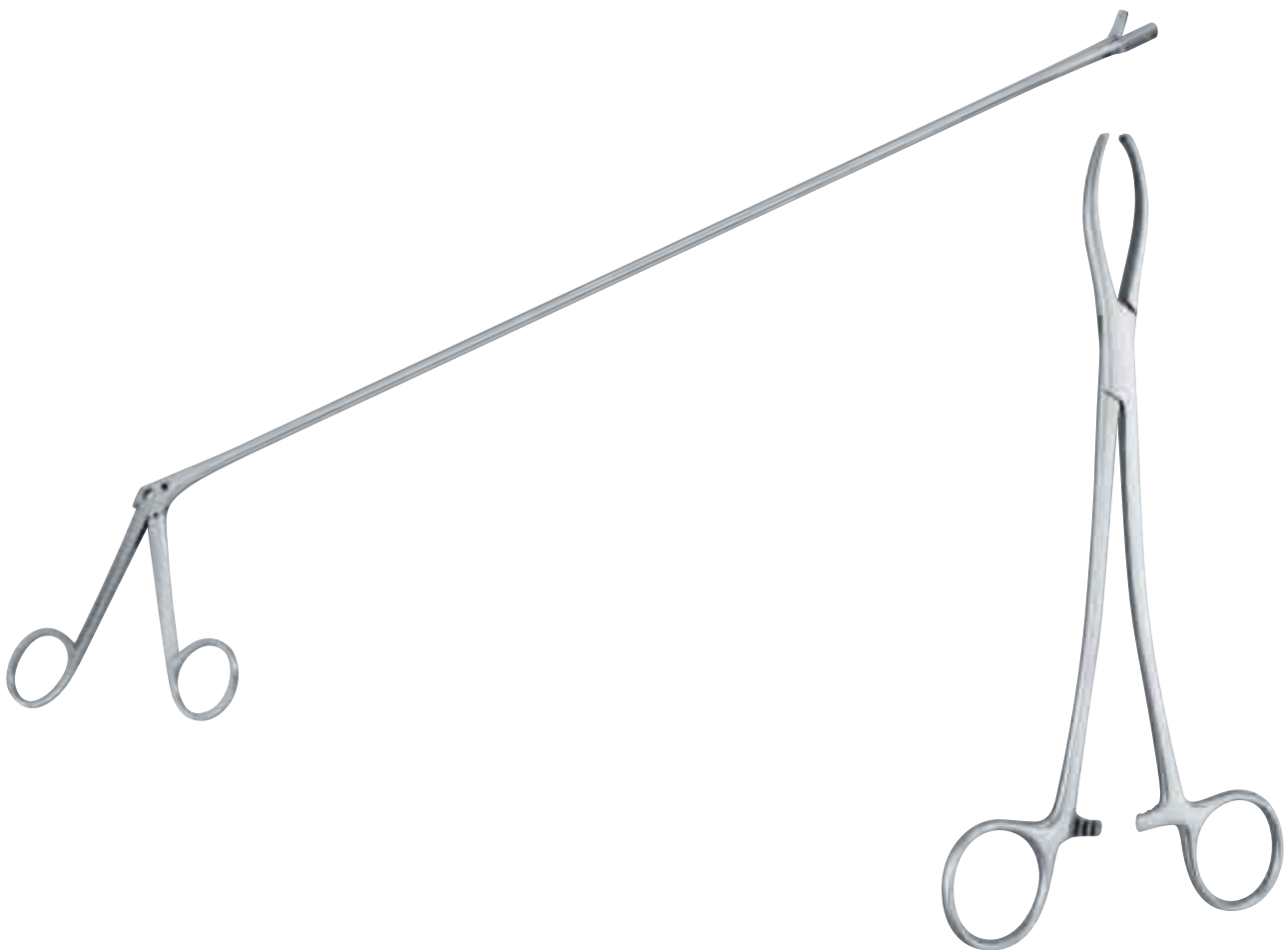

### Gewebe- und Darmfazzangen

Tissue and intestinal holding forceps

*Pinces intestinales et de tissue*  
*Pinzas para tejidos y intestinos*  
*Pinze per tessuti ed intestinali*



**ALLIS**

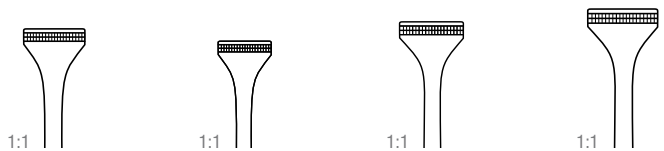

			Atrauma	Atrauma	Atrauma	Atrauma
155 mm – 6"	12-810-155	12-812-155	363-120-160			
190 mm – 7½"		12-812-190				
200 mm – 8"				363-120-200		
230 mm – 9"		12-812-230				
250 mm – 9¾"					363-120-250	
300 mm – 12"						363-120-300

Zähne  
Teeth  
Dents  
Dientes  
Denti

4 x 5

5 x 6



1:2

**ALLIS-BABY**

140 mm – 5½"	363-098-140
--------------	-------------

Zähne  
Teeth  
Dents  
Dientes  
Denti

4 x 5



1:2

**ALLIS-ADAIR**

155 mm – 6"	363-126-150
-------------	-------------

Zähne  
Teeth  
Dents  
Dientes  
Denti

10 x 11



1:3

**THOMS-ALLIS**

200 mm – 8"	12-820-200
-------------	------------

Zähne  
Teeth  
Dents  
Dientes  
Denti

6 x 7

**Gewebe- und Darmfazzangen**
*Tissue and intestinal holding forceps*
*Pinces intestinales et de tissue*
*Pinzas para tejidos y intestinos*
*Pinze per tessuti ed intestinali*

**BOYS-ALLIS**

1:2

150 mm – 6"	363-144-150
-------------	-------------

**Zähne**  
 Teeth  
 Dents  
 Dientes  
 Denti

5 x 6

**JUDD-ALLIS**

150 mm – 6"	12-816-150
190 mm – 7½"	12-816-190

**Zähne**  
 Teeth  
 Dents  
 Dientes  
 Denti

3 x 4

# Magen, Darm, Rektum

## Stomach, Intestines, Rectum

### Gewebe- und Darmfazzangen

Tissue and intestinal holding forceps

*Pinces intestinales et de tissue*  
*Pinzas para tejidos y intestinos*  
*Pinze per tessuti ed intestinali*



1:2  
**LITTLEWOOD**

185 mm – 7 ¼"    12-828-185

Zähne  
Teeth  
Dents  
Dientes  
Denti

2 x 3



1:3  
**LOCKWOOD**

200 mm – 8"    429-166-200



1:2  
**WILLIAMS**

160 mm – 6 ¼"    363-176-160



**BABCOCK**

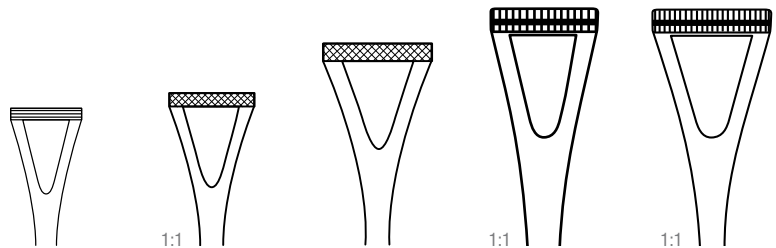

		almedur	almedur	Atrauma	Atrauma
160 mm – 6 ¼"	12-842-160	363-160-160		363-164-160	
180 mm – 7"	12-842-180		363-160-180		
200 mm – 8"	12-842-195		363-160-200		363-164-200
240 mm – 9 ½"	12-842-240				



**Gewebe- und Darmfazzangen**  
*Tissue and intestinal holding forceps*
*Pinces intestinales et de tissue*  
*Pinzas para tejidos y intestinos*  
*Pinze per tessuti ed intestinali*

**DUVAL**

			almedur	Atrauma	Atrauma	Atrauma
180 mm – 7"	363-166-180			429-536-180		
200 mm – 8"	12-852-014	12-852-028	363-170-200		429-536-200	
230 mm – 9"		363-168-230				429-536-230



### Darm- und Magenklappen

Intestinal and stomach clamps

*Pinces-clamps pour l'intestin et l'estomac*  
*Pinzas-clamps para el intestino y el estómago*  
*Pinze per intestino e stomaco*



1:2  
**BABY-KOCHER**

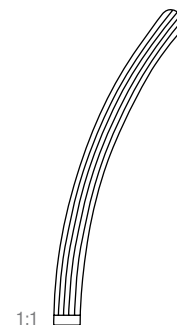
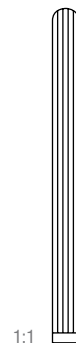

130 mm – 5"	12-878-130	12-879-130
-------------	------------	------------

**Darmklemme für Kinder, sehr elastisch**  
 Intestinal clamp for children, very elastic blades  
 Pince intestinal pour enfants, très élastique  
 Pinza intestinal para niños, muy elástica  
 Pinza intestinale per bambini, molto elastica



**ALLEN**

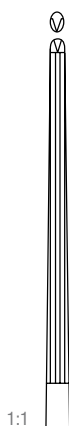

155 mm – 6"	429-394-160
200 mm – 8"	429-394-200

**Zähne**  
 Teeth  
 Dents  
 Dientes  
 Denti

1 x 2

**Darmklemme für Kinder**  
 Intestinal clamp for children  
 Pince intestinal pour enfants  
 Pinza intestinal para niños  
 Pinza intestinale per bambini

**Darm- und Magenklappen**

*Intestinal and stomach clamps*

*Pinces-clamps pour l'intestin et l'estomac*

*Pinzas-clamps para el intestino y el estómago*

*Pinze per intestino e stomaco*



**BABY-DOYEN**

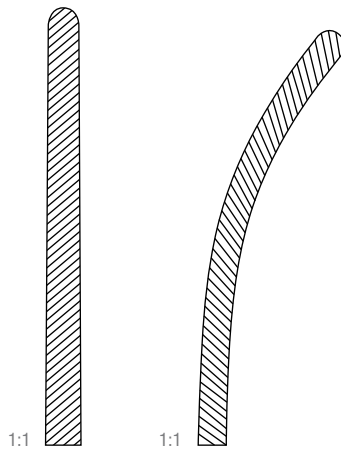

180 mm – 7"	12-870-180	12-871-180
210 mm – 8 ¼"	12-870-210	12-871-210

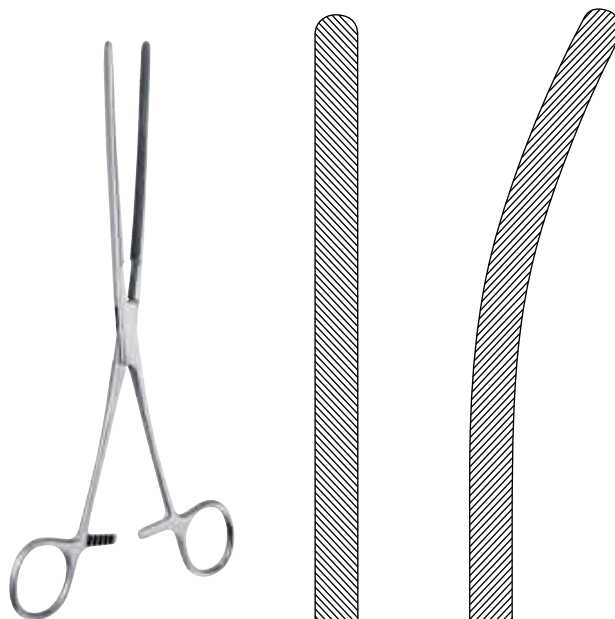

**DOYEN**

230 mm – 9"	12-872-230	12-873-230
-------------	------------	------------

# Magen, Darm, Rektum

## Stomach, Intestines, Rectum

### Darm- und Magenklammen

Intestinal and stomach clamps

Pinces-clamps pour l'intestin et l'estomac

Pinzas-clamps para el intestino y el estómago

Pinze per intestino e stomaco

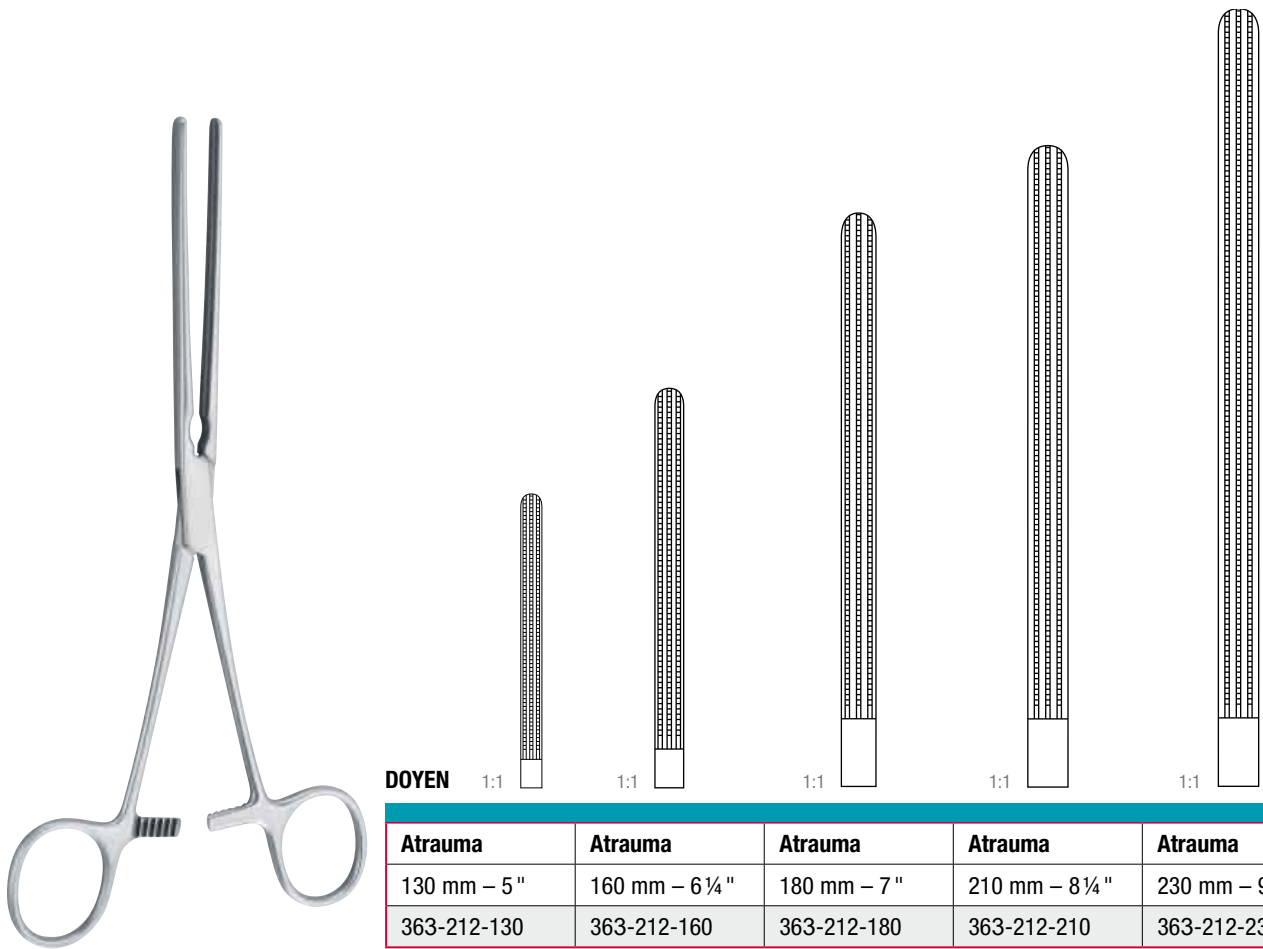

Atrauma	Atrauma	Atrauma	Atrauma	Atrauma
130 mm – 5"	160 mm – 6 ¼"	180 mm – 7"	210 mm – 8 ¼"	230 mm – 9"
363-212-130	363-212-160	363-212-180	363-212-210	363-212-230



**Darm- und Magenklammern**

*Intestinal and stomach clamps*

*Pinces-clamps pour l'intestin et l'estomac*

*Pinzas-clamps para el intestino y el estómago*

*Pinze per intestino e stomaco*

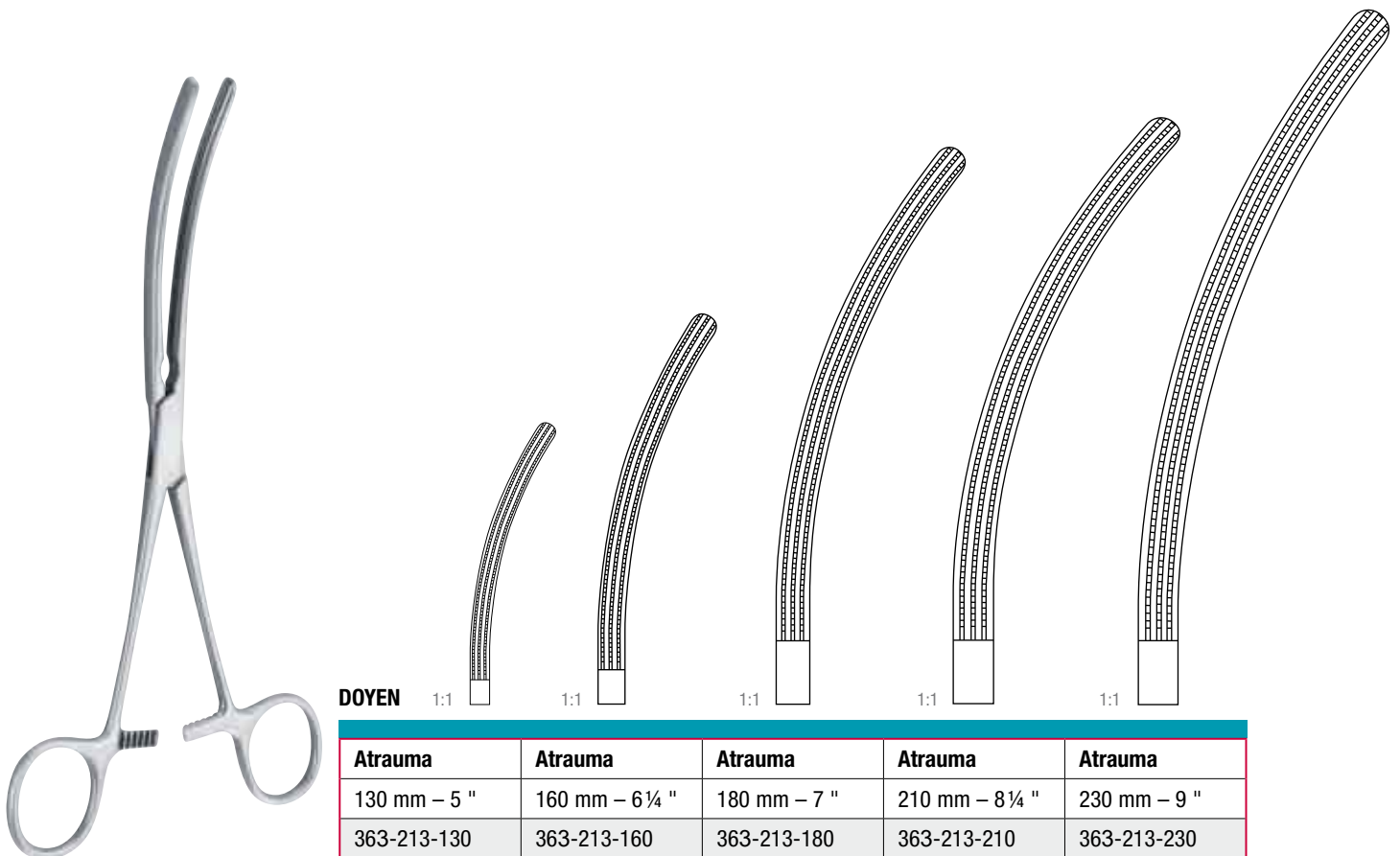

**DOYEN**

1:1

1:1

1:1

1:1

1:1

Atrauma	Atrauma	Atrauma	Atrauma	Atrauma
130 mm – 5 "	160 mm – 6 ¼ "	180 mm – 7 "	210 mm – 8 ¼ "	230 mm – 9 "
363-213-130	363-213-160	363-213-180	363-213-210	363-213-230

# Magen, Darm, Rektum

## Stomach, Intestines, Rectum

### Darm- und Magenklappen

*Intestinal and stomach clamps*

*Pinces-clamps pour l'intestin et l'estomac*

*Pinzas-clamps para el intestino y el estómago*

*Pinze per intestino e stomaco*

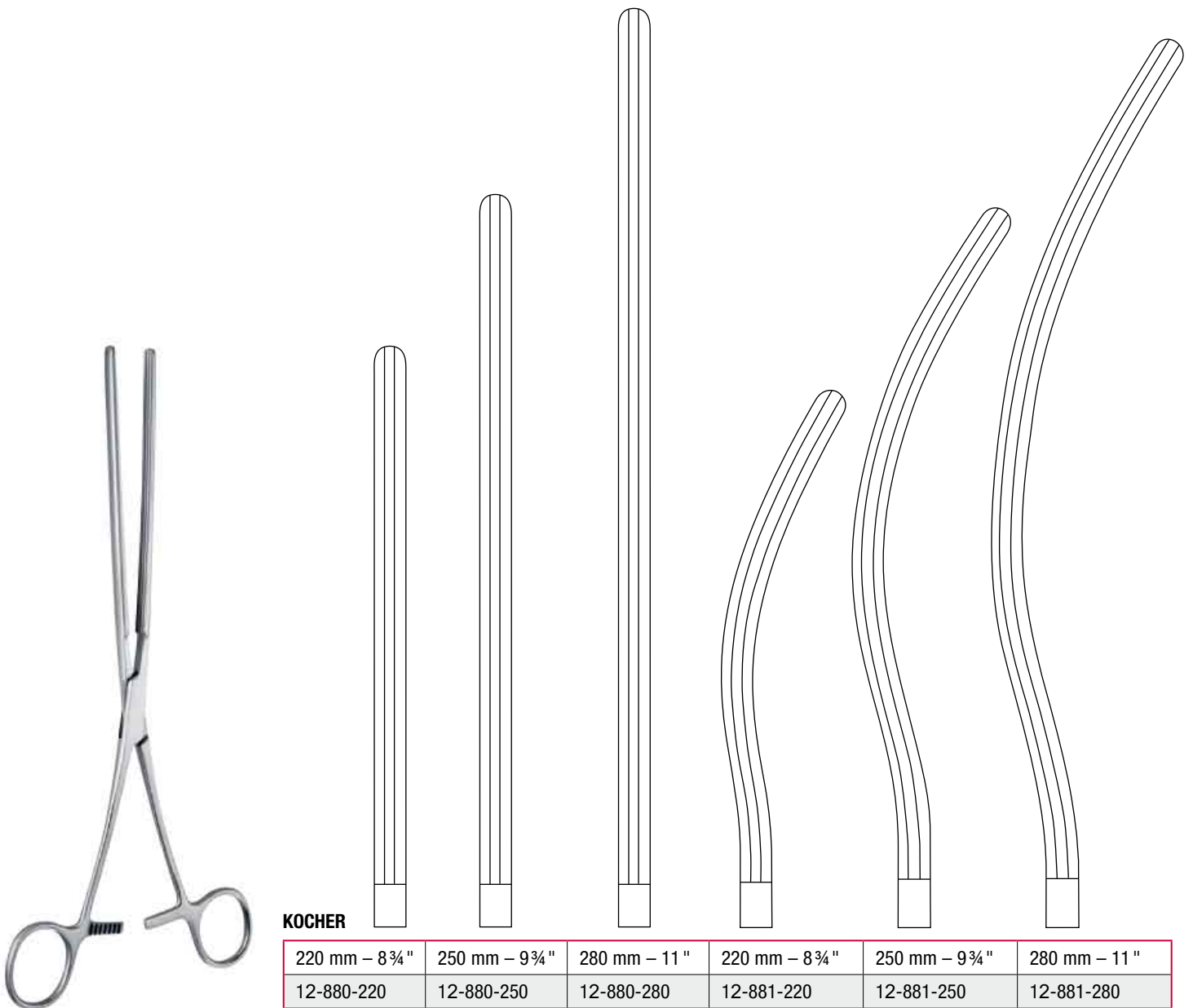

**KOCHER**

220 mm – 8¾"	250 mm – 9¾"	280 mm – 11"	220 mm – 8¾"	250 mm – 9¾"	280 mm – 11"
12-880-220	12-880-250	12-880-280	12-881-220	12-881-250	12-881-280

**Darm- und Magenklammern**
*Intestinal and stomach clamps*
*Pinces-clamps pour l'intestin et l'estomac*
*Pinzas-clamps para el intestino y el estómago*
*Pinze per intestino e stomaco*

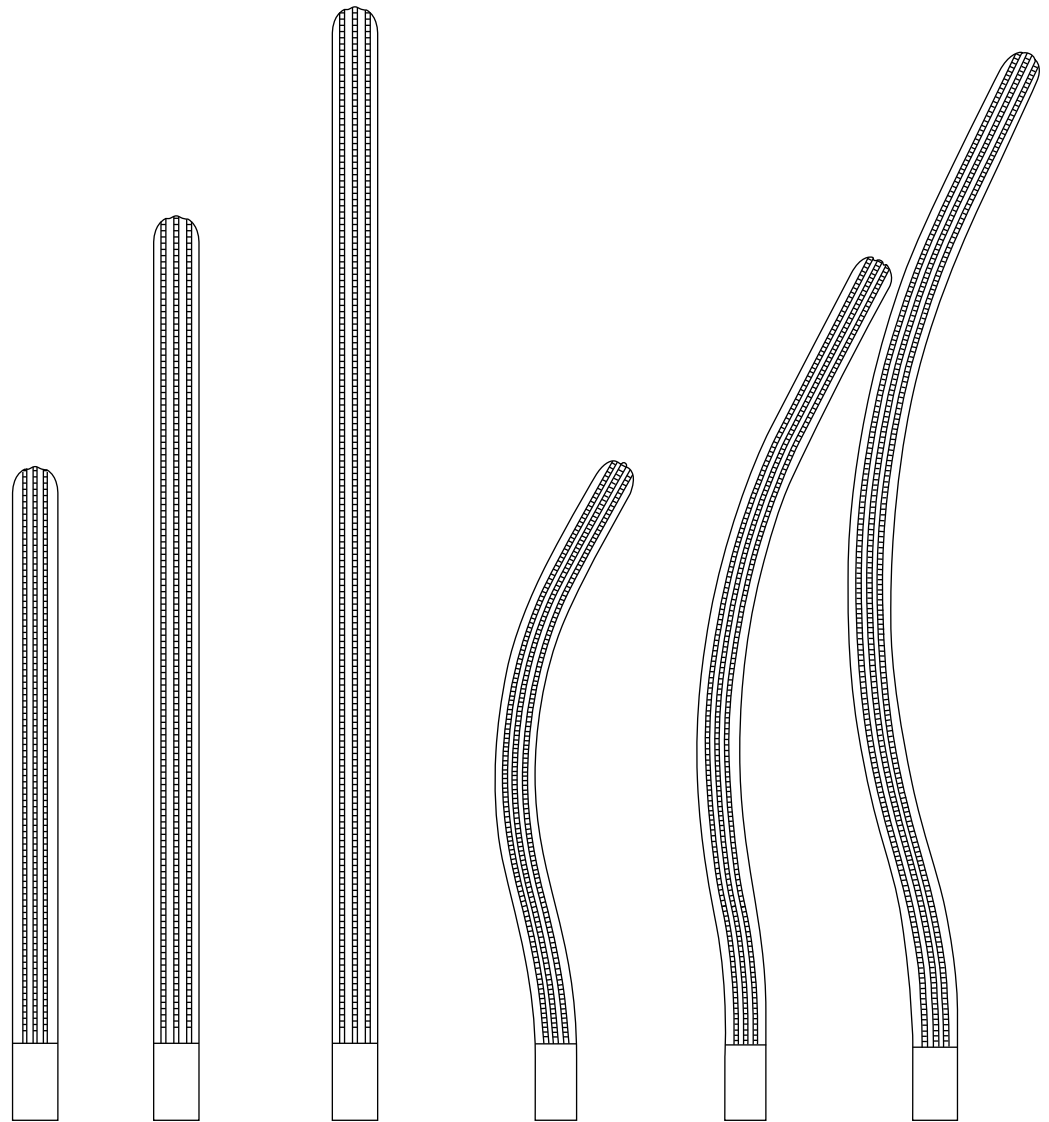
**KOCHER**

Atrauma	Atrauma	Atrauma	Atrauma	Atrauma	Atrauma
220 mm – 8 ¾ "	250 mm – 9 ¾ "	280 mm – 11 "	220 mm – 8 ¾ "	250 mm – 9 ¾ "	280 mm – 11 "
363-222-220	363-222-250	363-222-280	363-223-220	363-223-250	363-223-280

# Magen, Darm, Rektum

## Stomach, Intestines, Rectum

### Darm- und Magenklappen

Intestinal and stomach clamps

*Pinces-clamps pour l'intestin et l'estomac*  
*Pinzas-clamps para el intestino y el estómago*  
*Pinze per intestino e stomaco*



**MAYO-ROBSON**

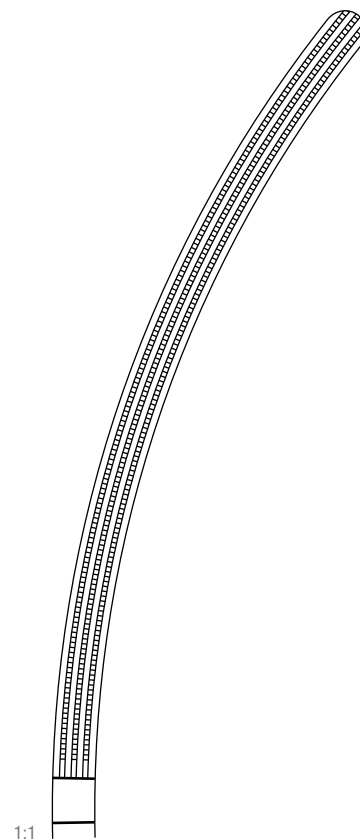
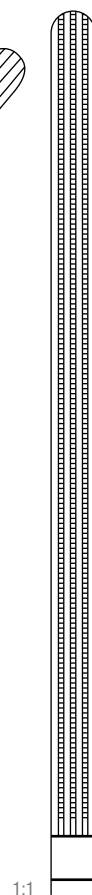
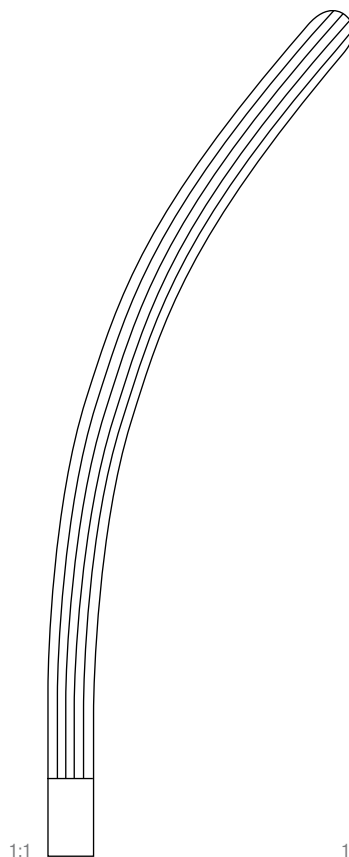
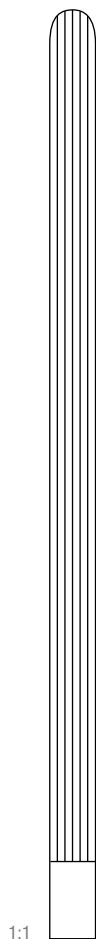

			Atrauma	Atrauma
230 mm – 9"	12-886-230	12-887-230		
250 mm – 9¾"	12-890-250	12-891-250	363-232-250	363-233-250



**Darm- und Magenklappen**

*Intestinal and stomach clamps*

*Pinces-clamps pour l'intestin et l'estomac*

*Pinzas-clamps para el intestino y el estómago*

*Pinze per intestino e stomaco*



1:2

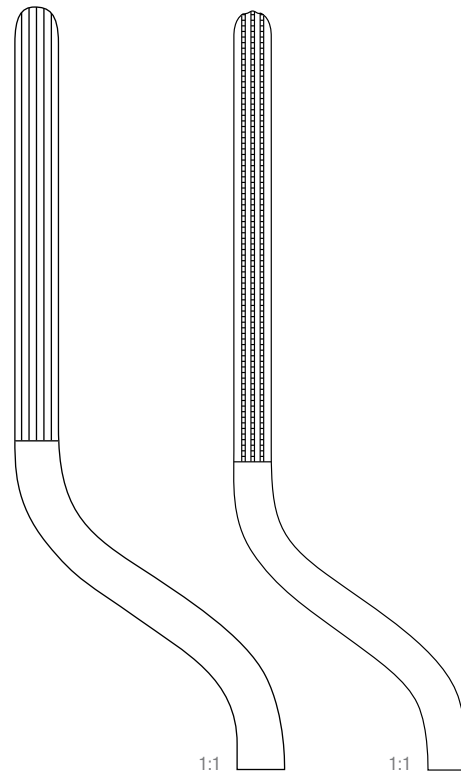

**BRUNNER**

		Atrauma
240 mm – 9 ½"	363-256-240	363-262-240



**Darm- und Magenklappen**

*Intestinal and stomach clamps*

*Pinces-clamps pour l'intestin et l'estomac*

*Pinzas-clamps para el intestino y el estómago*

*Pinze per intestino e stomaco*



1:2

**LANE**

300 mm – 12"

1:1

12-780-300

1:1

12-781-300

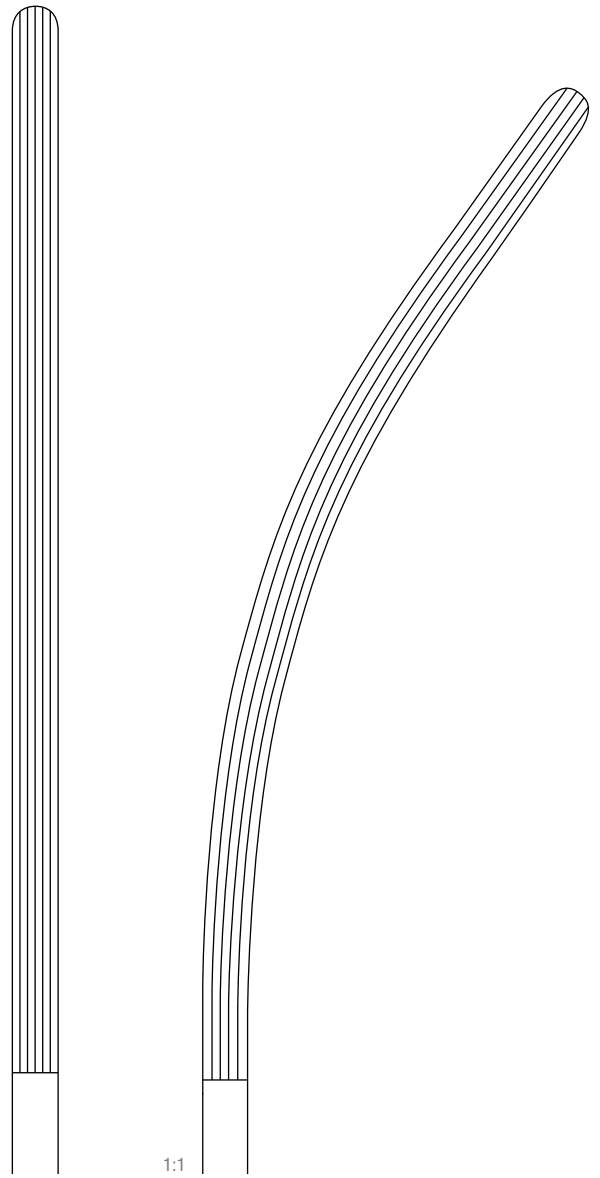

**Darm- und Magenklappen**

*Intestinal and stomach clamps*

*Pinces-clamps pour l'intestin et l'estomac*

*Pinzas-clamps para el intestino y el estómago*

*Pinze per intestino e stomaco*



1:2

**RESANO**

1:1

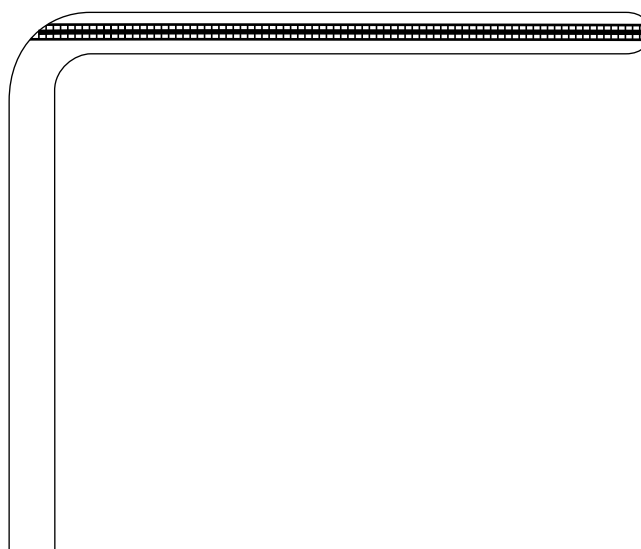

	<b>Atrauma</b>
300 mm – 12"	429-583-300

**Rektum-Anastomosenklemmen**  
*Sigmoid anastomosis forceps*

*Pinces pour anastomoses rectales*  
*Pinzas para anastomosis rectales*  
*Pinze per anastomosi rettali*

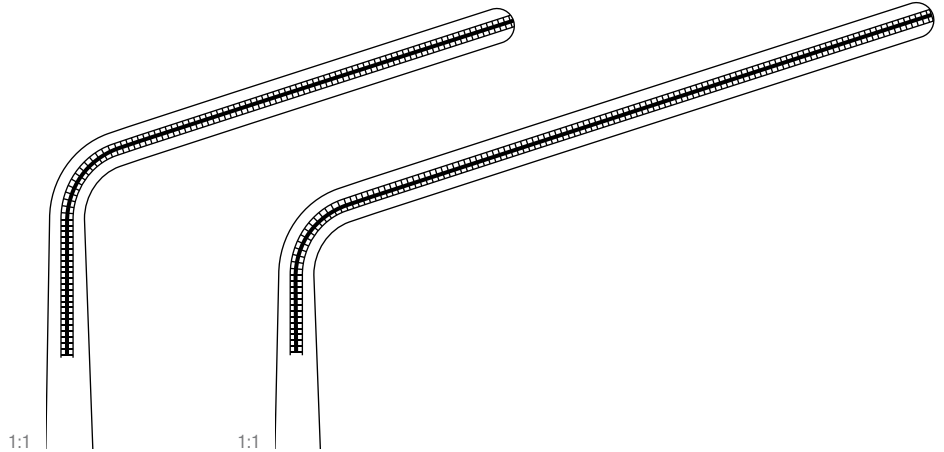

HAYES

Atrauma	Atrauma
260 mm – 10 ¼"	280 mm – 11"
429-577-260	429-577-280

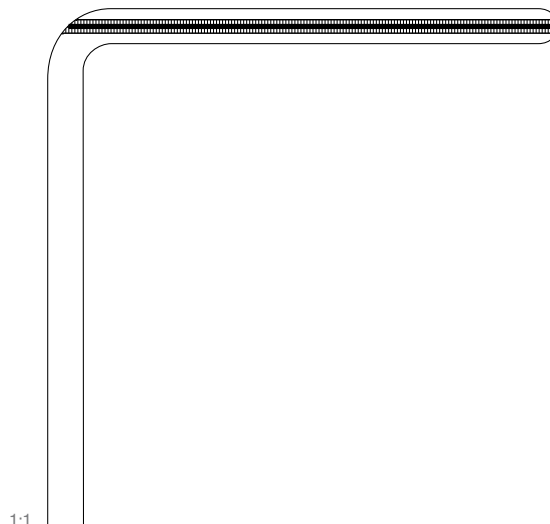

FEHLAND

		Atrauma
230 mm – 9"	363-237-230	363-243-230

1:2



**Organfasszangen**
*Organ grasping forceps*
*Pinces pour saisir des organes*
*Pinzas para sacar órganos*
*Pinze per afferrare organi*

1:2

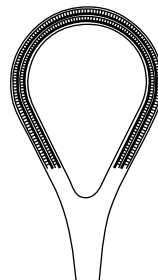

	Atrauma
250 mm – 9 3/4"	412-262-250

**Organfasszange mittel, 250 mm**  
 Organ grasping forceps medium, 250 mm  
 Pince medium pour saisir des organes, 250 mm  
 Pinza mediano para sacar órganos, 250 mm  
 Pinze per afferrare organi, 250 mm

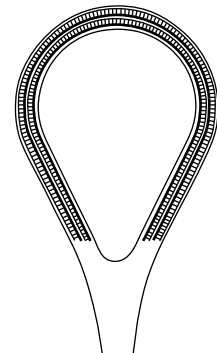

	Atrauma
260 mm – 10 1/4"	412-262-260

**Organfasszange mittel, 250 mm**  
 Organ grasping forceps medium, 250 mm  
 Pince medium pour saisir des organes, 250 mm  
 Pinza mediano para sacar órganos, 250 mm  
 Pinze per afferrare organi, 250 mm

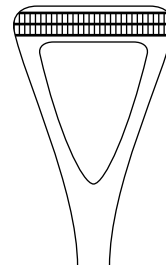
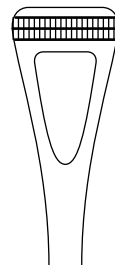

1:2

**SCHEIBE**

Atrauma	Atrauma	Atrauma
180 mm – 7"	200 mm – 8"	230 mm – 9"
429-536-180	429-536-200	429-536-230

**schmal**  
 narrow  
 étroit  
 estrecho  
 stretto

**mittel**  
 medium  
 moyen  
 mediano  
 medio

**breit**  
 wide  
 large  
 ancho  
 largo

**Darmquetschklemmen**  
*Intestinal and pylorus clamps*  
*Ecraseur pour l'intestin*  
*Pinzas intestinales para piloro*  
*Schiacciatori intestinali*



1:2

**PAYR-BABY**

150 mm – 6"

55-123-150

**mit Stift**  
 with pin  
 avec cheville  
 con perno  
 con perno

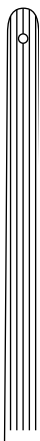

1:1



1:2

**PAYR**

1:1

1:1

1:1

210 mm – 8¼"

290 mm – 11½"

350 mm 13¾"

55-127-210

55-135-290

55-143-350

**mit Stift**  
 with pin  
 avec cheville  
 con perno  
 con perno

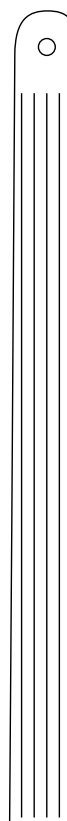
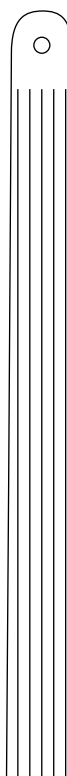
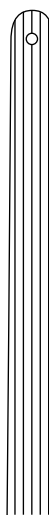

**Darm- und Anastomosenklemmen**

*Intestinal and anastomosis clamp forceps*

*Pinces-clamps intestinales et à anastomose*

*Pinzas-clamps intestinales y para anastomosis*

*Pinze intestinali e per anastomosi*



1:2

**DE MARTEL-  
WOLFSON**

85 mm – 3¼"

55-176-085



1:2

**DE MARTEL-  
WOLFSON**

230 mm – 9"

55-176-230



1:2

**DE MARTEL-  
WOLFSON**

260 mm – 10¼"

55-174-260

**Darm- und Anastomosenklemmen**

*Intestinal and anastomosis clamp forceps*

*Pinces-clamps intestinales et à anastomose*

*Pinzas-clamps intestinales y para anastomosis*

*Pinze intestinali e per anastomosi*

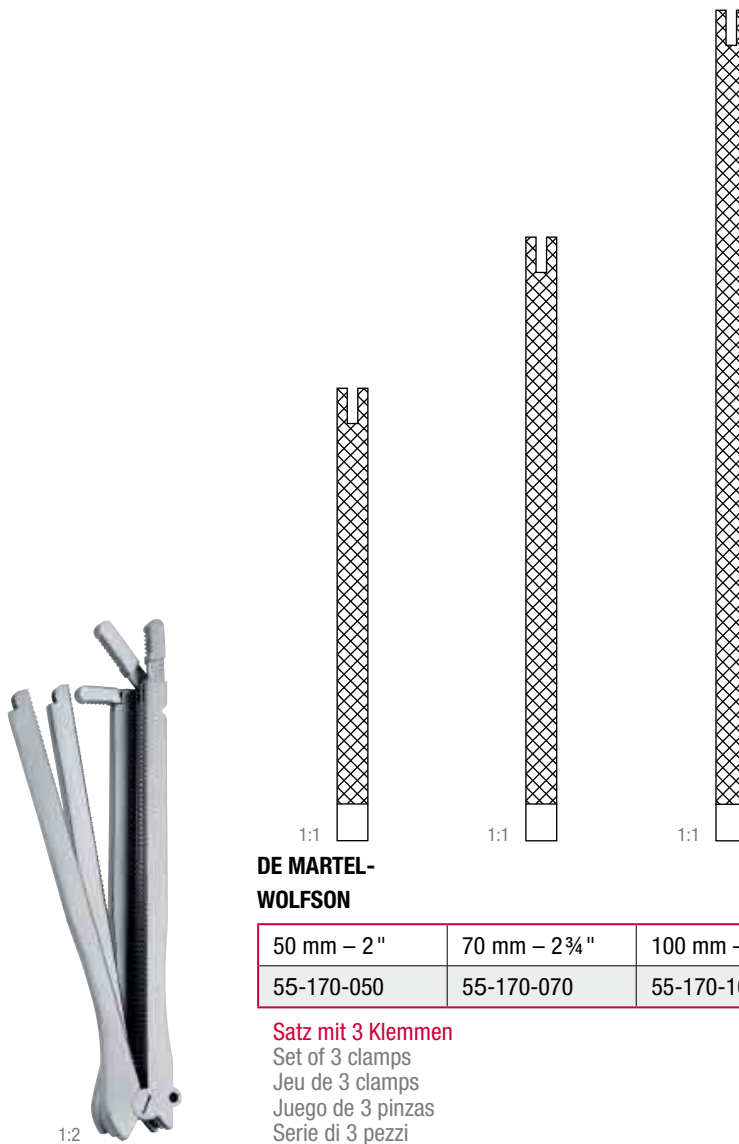

**DE MARTEL-  
WOLFSON**

50 mm – 2"	70 mm – 2¾"	100 mm – 4"
55-170-050	55-170-070	55-170-100

**Satz mit 3 Klemmen**

Set of 3 clamps

Jeu de 3 clamps

Juego de 3 pinzas

Serie di 3 pezzi

**Mastdarm-Spekula**

*Rectal specula*

*Spéculum pour le rectum*

*Espéculos rectales*

*Specoli rettali*



**SIMS**

1:2

1:2

	x = 80 mm x 15 mm	x = 80 mm x 15 mm	x = 80 mm x 15 mm
150 mm – 6"	367-111-150	55-371-150	367-113-150

**mit Kaltlichtaufsatz**  
with F.O. light carrier  
avec support lumière froide  
con guía de luz fría  
con supporto per luce fredda



**MATHIEU**

1:2

	x = 90 mm
195 mm – 7¾"	55-377-195

**Mastdarm-Spekula**

*Rectal specula*

*Spéculums pour le rectum*

*Espéculos rectales*

*Specoli rettali*



**PRATT**

1:2

	x = 80 mm x 25 mm
205 mm – 8"	367-117-000



**CZERNY**

1:2

	x = 110 mm x 25 mm
220 mm – 8¾"	367-101-220

**Anuskope – Sphinkterskope**  
*Anuscopes – Sphincteroscopes*  
*Anuscopes – Sphinctérosopes*  
*Anoscopios – Esfinteroscopios*  
*Anoscopi – Sfinteroscopi*

**IVES-FANSLER**

1:2

	x = 90 mm	x = 90 mm
22 mm Ø	367-206-220	429-647-650

**KELLY**

	x = 50 mm
21 mm Ø	55-441-001
27 mm Ø	55-441-002

mit Kaltlichtaufsatz  
 with F.O. light carrier  
 avec support lumière froide  
 con guía de luz fría  
 con supporto per luce fredda

**BENSAUDE**

	185 mm – 7 ¼"
	x = 55 mm
19 mm Ø	429-655-010
22 mm Ø	429-655-020

**Anuskope – Sphinkterskope**  
*Anusscopes – Sphincteroscopes*  
*Anusscopes – Sphinctérosopes*  
*Anoscopios – Esfinteroscopios*  
*Anoscopi – Sfinteroscopi*



**HIRSCHMANN**

16 mm Ø	x = 65 mm	55-421-001
19 mm Ø	x = 65 mm	55-421-002
22 mm Ø	x = 65 mm	55-421-003



**HIRSCHMANN**

16 mm Ø	55-423-001
19 mm Ø	55-423-002
24 mm Ø	55-423-003
25 mm Ø	55-423-004

**mit Kaltlicht**  
 with F.O. light  
 avec lumière froide  
 con de luz fría  
 con per luce fredda

55-425-000

**Kaltlichtadapter, ALLGAIER / Storz Anschluss**  
 Cold light, ALLGAIER / Storz connector  
 Adaptateur lum. froide, connection ALLGAIER / Storz  
 Adaptator luz fría, conexión ALLGAIER / Storz  
 Adattatore luce freddo, attacco ALLGAIER / Storz



**Analspreizer**

*Rectal specula*

*Spéculums pour le rectum*

*Espéculos rectales*

*Divaricatore anale*



**SMITH-BUIE**

	x = 75 mm x 23 mm
150 mm – 6 "	55-391-150

**Max. Spreizweite 115 mm**

Max. spread 115 mm

Écartement maximal 115 mm

Apertura máxima 115 mm

Apertura massima 115 mm

### Analspreizer

*Rectal specula*

*Spéculums pour le rectum*

*Espéculos rectales*

*Divaricatore anale*



1:2

ALAN PARKS

140 mm – 5 ½"	367-143-000
---------------	-------------

**komplett mit 2 Paar Valven und 1 Mittelvalve**  
 complete with 2 pair of blades and 1 center blade  
 complet avec 2 paires des valves et 1 valve centrale  
 completo con 2 juegos de valvas y 1 valva central  
 completo con 2 paia di valve e 1 valva centrale

22 mm x 75 mm	367-143-070
---------------	-------------

**Seitenvalven alleine (Paar)**  
 Lateral blades only (pair)  
 Valves latérales seules (paire)  
 Valvas laterales solas (par)  
 Valve laterali solo (paio)

22 mm x 95 mm	367-143-090
---------------	-------------

**Seitenvalven alleine (Paar)**  
 Lateral blades only (pair)  
 Valves latérales seules (paire)  
 Valvas laterales solas (par)  
 Valve laterali solo (paio)

25 mm x 95 mm	367-143-093
---------------	-------------

**Seitenvalven alleine (Paar)**  
 Lateral blades only (pair)  
 Valves latérales seules (paire)  
 Valvas laterales solas (par)  
 Valve laterali solo (paio)



1:2

ALAN PARKS

140 mm – 5 ½"	367-144-000
---------------	-------------

**komplett mit 2 Paar Valven und 1 Mittelvalve, mit Kaltlichtanschluss ALLGAIER/Wolf**  
 complete with 2 pair of blades and 1 center blade, with cold light connector ALLGAIER/Wolf  
 complet avec 2 paires des valves et 1 valve centrale, avec raccord de lum. froide ALLGAIER/Wolf  
 completo con 2 juegos de valvas y 1 valva central, con connector de luz fría ALLGAIER/Wolf  
 completo con 2 paia di valve e 1 valva centrale, con attacco di luce fredda ALLGAIER/Wolf

367-144-002
-------------

**Kaltlicht-Aufsatz alleine**  
 F.O. light carrier only  
 Support lumière froide seule  
 Soporte de luz fría sola  
 Supporto per luce fredda solo

367-143-001
-------------

**Sperrer alleine**  
 Specula only  
 Speculum seules  
 Espéculo sola  
 Divaricatore solo

367-143-002
-------------

**Mittelvalve alleine**  
 Central blade only  
 Valve centrale seule  
 Valva central sola  
 Valva centrale solo

**Rektoskop**  
*Rectoscope*

*Rectoscope*  
*Rectoscopio*  
*Rettoscopio*



**STRAUSS**

367-157-000

**Kaltlicht-Rektoskop, komplett:**

F/O Rektoskopkopf mit Zweiwegehahn, Verschlussdeckel, Teleskop und Griff, je1 Rektoskoptubus in 200 mm, 250 mm und 300 mm mit 20 mm Ø, mit Obturator und F/O Lichtträger Wolf-Anschluss, Doppelgebläse mit Kaltlichteinrichtung

**Cold-light rectoscope, complete:**

F/O Rectoscope-head with two-way stop cock, lens cover and telescope handle, 3 rectoscope-tubes 20 mm Ø 200 mm, 250 mm and 300 mm with obturator and F/O light-carrier Wolf, with double blower, with cold light connection

**Rectoscope à lumière froide, complet:**

F/O tête de rectoscope avec robinet, protecteur de lentille, optique et manche, 3 tubes de rectoscope 20 mm Ø, 200 mm, 250 mm et 300 mm de longueur, avec mandrin et porte-lumière Wolf (F/O), souffleur et connecteur de lumière froide.

**Rectoscopio de luz fría, completo:**

F/O cabeza de rectoscopio, con robinete protector de lentes, óptica y mango, 3 tubos de rectoscopia de 20 mm, Ø 200 mm, 250 mm y 300 mm de longitud, con obturador y connector de luz fría Wolf y soplador.

**Luce fredda-Rettoscopio, completo:**

Testa di rettoscopio con fibre ottiche, con rubinetto a due vie, copri-lente e impugnatura per ottica, 3 tubi per rettoscopio 20 mm Ø, 200 mm, 250 mm e 300 mm con otturatore e cavo luce, insufflatore a doppia palla e connettore per cavo luce, allacciamento Wolf.

55-425-000

**Kaltlichtadapter ALLGAIER/Storz**

Cold light connector ALLGAIER/Storz  
Raccord de lumière froide ALLGAIER/Storz  
Connector de luz fría ALLGAIER/Storz  
Attacco luce fredda ALLGAIER/Storz

# Magen, Darm, Rektum

## Stomach, Intestines, Rectum

### Mastdarm-Biopsiezangen

Rectal biopsy forceps

Pinces pour la biopsie rectale

Pinzas para biopsia rectal

Pinze taglianti per biopsia rettale

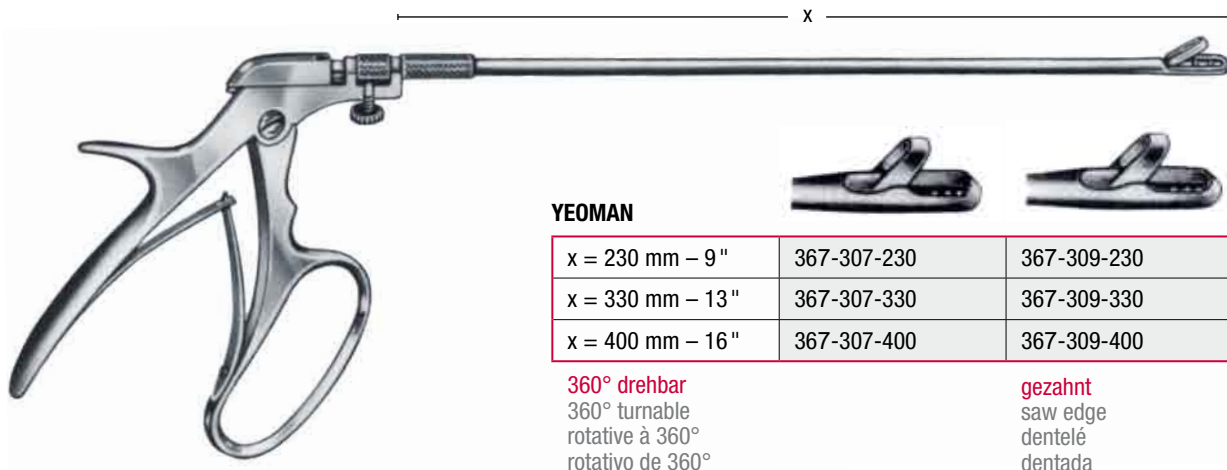

#### YEOMAN

x = 230 mm – 9"	367-307-230	367-309-230
x = 330 mm – 13"	367-307-330	367-309-330
x = 400 mm – 16"	367-307-400	367-309-400

**360° drehbar**  
360° turnable  
rotative à 360°  
rotativo de 360°  
rotativa di 360°

**gezahnt**  
saw edge  
dentelé  
dentada  
dentata



#### TURREL

x = 230 mm – 9"	367-317-230	367-319-230
x = 330 mm – 13"	367-317-330	367-319-330
x = 400 mm – 16"	367-317-400	367-319-400

**360° drehbar**  
360° turnable  
rotative à 360°  
rotativo de 360°  
rotativa di 360°

**gezahnt**  
saw edge  
dentelé  
dentada  
dentata

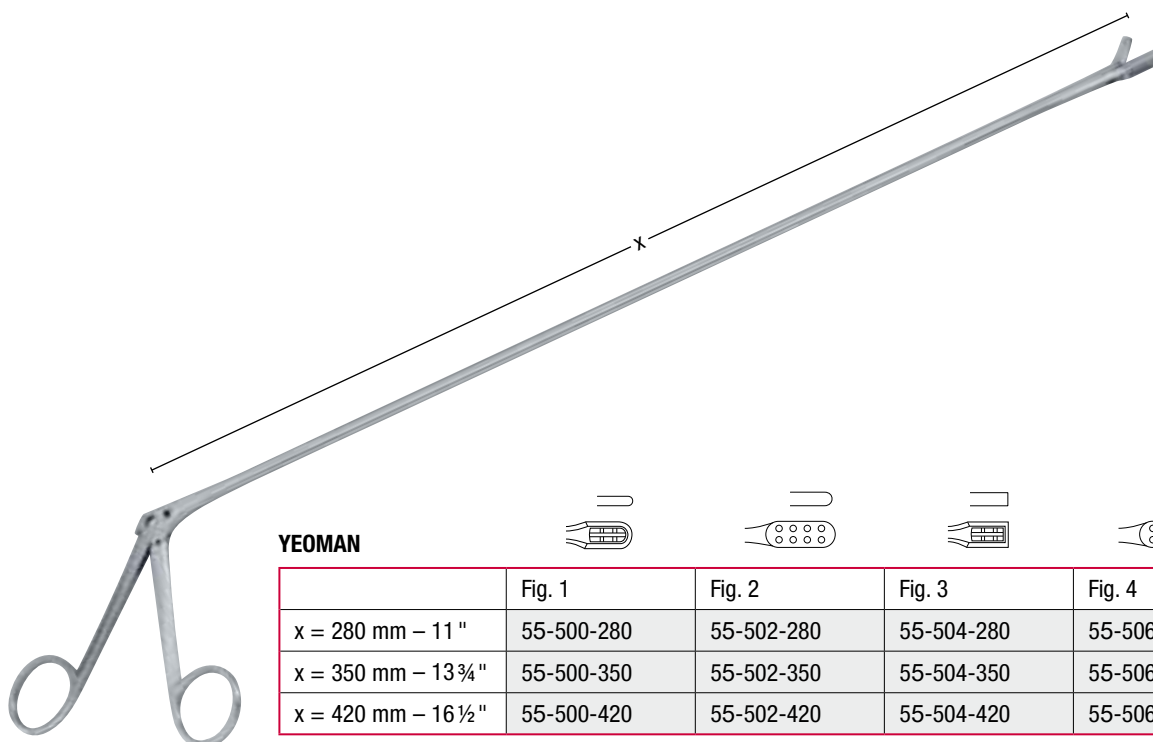

#### YEOMAN



	Fig. 1	Fig. 2	Fig. 3	Fig. 4
x = 280 mm – 11"	55-500-280	55-502-280	55-504-280	55-506-280
x = 350 mm – 13 3/4"	55-500-350	55-502-350	55-504-350	55-506-350
x = 420 mm – 16 1/2"	55-500-420	55-502-420	55-504-420	55-506-420

**Flexible Zangen**  
*Flexible forceps*  
*Pinces flexibles*  
*Pinzas flexibles*  
*Pinze flessibili*

	1.8 mm Ø	2.1 mm Ø	2.3 mm Ø	2.5 mm Ø	3.0 mm Ø	3.4 mm Ø
120 cm – 47 ¼"	AFF202-218-120	AFF202-221-120	AFF202-223-120	AFF202-225-120		
160 cm – 63"	AFF202-218-160	AFF202-221-160	AFF202-223-160	AFF202-225-160		
180 cm – 70 ¾"	AFF202-218-180	AFF202-221-180	AFF202-223-180	AFF202-225-180	AFF202-230-180	AFF202-234-180
230 cm – 90 ½"	AFF202-218-230	AFF202-221-230	AFF202-223-230	AFF202-225-230	AFF202-230-230	AFF202-234-230



	1.8 mm Ø	2.1 mm Ø	2.3 mm Ø	2.5 mm Ø	3.0 mm Ø	3.4 mm Ø
120 cm – 47 ¼"	AFF203-218-120	AFF203-221-120	AFF203-223-120	AFF203-225-120		
160 cm – 63"	AFF203-218-160	AFF203-221-160	AFF203-223-160	AFF203-225-160		
180 cm – 70 ¾"	AFF203-218-180	AFF203-221-180	AFF203-223-180	AFF203-225-180	AFF203-230-180	AFF203-234-180
230 cm – 90 ½"	AFF203-218-230	AFF203-221-230	AFF203-223-230	AFF203-225-230	AFF203-230-230	AFF203-234-230



	1.0 mm Ø	1.4 mm Ø	1.6 mm Ø	1.8 mm Ø	2.1 mm Ø	2.3 mm Ø
120 cm – 47 ¼"	AFF200-210-120	AFF200-214-120	AFF200-216-120	AFF200-218-120	AFF200-221-120	AFF200-223-120
160 cm – 63"	AFF200-210-160	AFF200-214-160	AFF200-216-160	AFF200-218-160	AFF200-221-160	AFF200-223-160
180 cm – 70 ¾"	AFF200-210-180	AFF200-214-180	AFF200-216-180	AFF200-218-180	AFF200-221-180	AFF200-223-180
230 cm – 90 ½"	AFF200-210-230	AFF200-214-230	AFF200-216-230	AFF200-218-230	AFF200-221-230	AFF200-223-230



	1.8 mm Ø	2.1 mm Ø	2.3 mm Ø
120 cm – 47 ¼"	AFF201-218-120	AFF201-221-120	AFF201-223-120
160 cm – 63"	AFF201-218-160	AFF201-221-160	AFF201-223-160
180 cm – 70 ¾"	AFF201-218-180	AFF201-221-180	AFF201-223-180
230 cm – 90 ½"	AFF201-218-230	AFF201-221-230	AFF201-223-230



# Magen, Darm, Rektum

## Stomach, Intestines, Rectum

**Flexible Zangen**  
*Flexible forceps*  
*Pinces flexibles*  
*Pinzas flexibles*  
*Pinze flessibili*



	1.8 mm Ø	2.1 mm Ø	2.3 mm Ø
120 cm – 47 ¼ "	AFF218-218-120	AFF218-221-120	AFF218-223-120
160 cm – 63 "	AFF218-218-160	AFF218-221-160	AFF218-223-160
180 cm – 70 ¾ "	AFF218-218-180	AFF218-221-180	AFF218-223-180
230 cm – 90 ½ "	AFF218-218-230	AFF218-221-230	AFF218-223-230



	1.0 mm Ø	1.4 mm Ø	1.6 mm Ø	1.8 mm Ø	2.3 cm Ø	3.0 cm Ø
120 cm – 47 ¼ "	AFF209-210-120	AFF209-214-120	AFF209-216-120	AFF209-218-120	AFF209-223-120	
160 cm – 63 "	AFF209-210-160	AFF209-214-160	AFF209-216-160	AFF209-218-160	AFF209-223-160	
180 cm – 70 ¾ "	AFF209-210-180	AFF209-214-180	AFF209-216-180	AFF209-218-180	AFF209-223-180	AFF209-230-180
230 cm – 90 ½ "	AFF209-210-230	AFF209-214-230	AFF209-216-230	AFF209-218-230	AFF209-223-230	AFF209-230-230



	1.8 mm Ø	2.3 mm Ø	3.0 mm Ø
120 cm – 47 ¼ "	AFF208-218-120	AFF208-223-120	
160 cm – 63 "	AFF208-218-160	AFF208-223-160	
180 cm – 70 ¾ "	AFF208-218-180	AFF208-223-180	AFF208-230-180
230 cm – 90 ½ "	AFF208-218-230	AFF208-223-230	AFF208-230-230

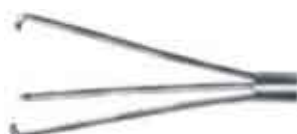

	1.0 mm Ø	1.8 mm Ø	2.3 mm Ø
120 cm – 47 ¼ "	AFF212-210-120	AFF212-218-120	AFF212-223-120
160 cm – 63 "	AFF212-210-160	AFF212-218-160	AFF212-223-160
180 cm – 70 ¾ "	AFF212-210-180	AFF212-218-180	AFF212-223-180
230 cm – 90 ½ "	AFF212-210-230	AFF212-218-230	AFF212-223-230

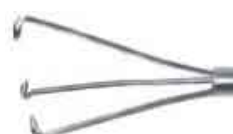

	1.8 mm Ø	2.3 mm Ø
120 cm – 47 ¼ "	AFF214-218-120	AFF214-223-120
160 cm – 63 "	AFF214-218-160	AFF214-223-160
180 cm – 70 ¾ "	AFF214-218-180	AFF214-223-180
230 cm – 90 ½ "	AFF214-218-230	AFF214-223-230



**Hämorrhoidal-Zangen**  
*Haemorrhoidal forceps*  
*Pinces hémorroidales*  
*Pinzas hemorroidales*  
*Pinze emorroidali*



1:2  
**LUER**

245 mm – 9¾"

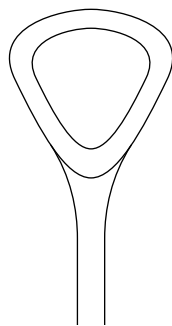

429-746-240



**MCGIVNEY**

1:2

1:2

190 mm – 7½"

12-488-001

12-488-002

**1 x gebogen**  
single curved  
courbé simple  
curvado simple  
curvatura singola

**2 x gebogen**  
double curved  
courbé double  
curvado doble  
curvatura doppia

**Polypenfasszangen**  
*Polypus grasping forceps*  
*Pinces pour saisir les polypes*  
*Pinzas para coger pólipos*  
*Pinze per afferrare polipi*



**HEYWOOD-SMITH** 1:2

200 mm – 8"

367-398-210

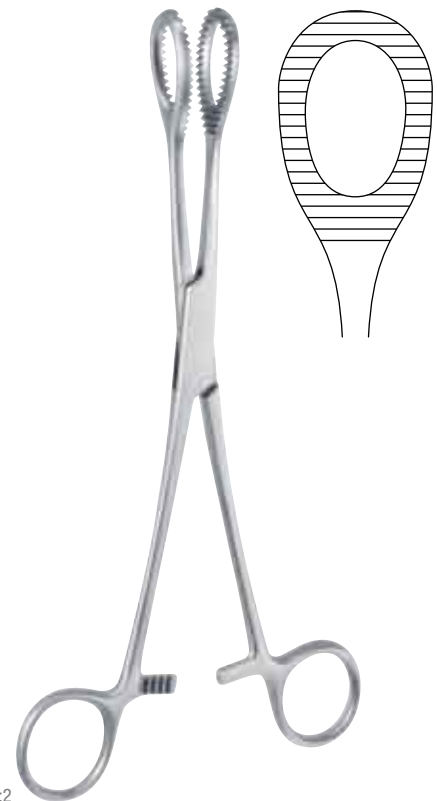

**HEYWOOD-SMITH** 1:2

210 mm – 8¼"

367-400-210

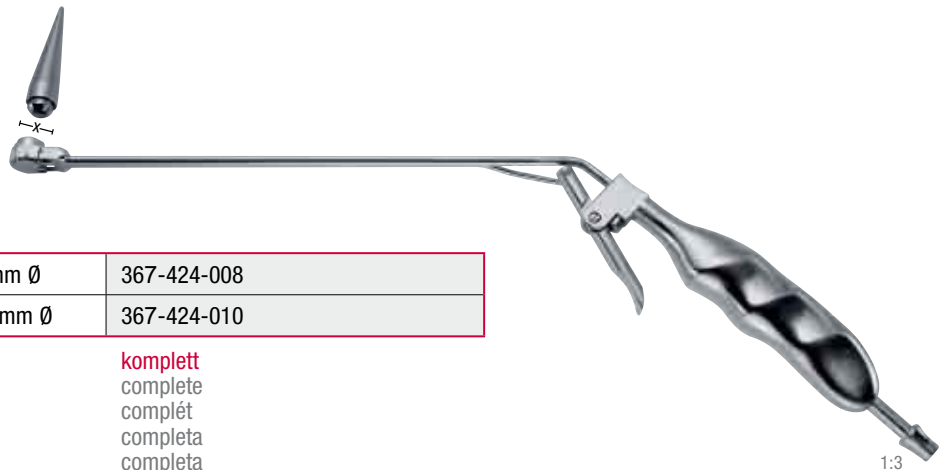

**Hämorrhoidal-Ligatoren**
*Haemorrhoidal ligators*
*Ligateurs hémorroïdales*
*Ligadores hemorroidales*
*Legatori emorroidali*

**LURZ**

x = 8 mm Ø	367-424-008
x = 10 mm Ø	367-424-010

**komplett**  
 complete  
 complét  
 completa  
 completa

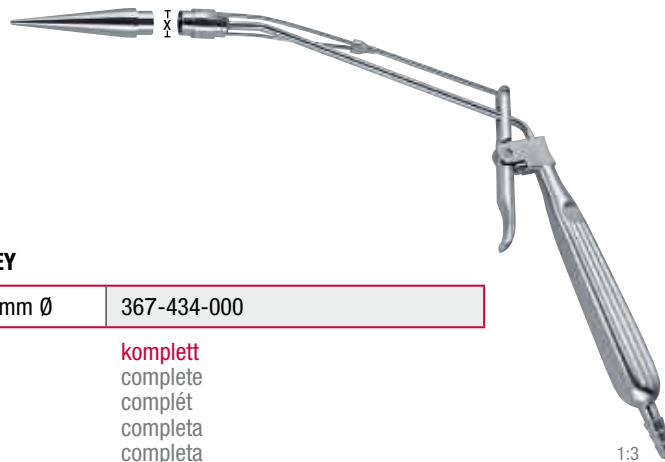
1:3

**MCGIVNEY**

x = 10 mm Ø	367-434-000
-------------	-------------

**komplett**  
 complete  
 complét  
 completa  
 completa

1:3

367-429-000
-------------

**Gummiringe, Packung à 100 Stück**

Rubber rings, package of 100 pieces

Anneaux de caoutchouc à ligatures, paquet de 100 pièces

Anillos de goma para ligaduras, paquete de 100 piezas

Anelli di gomma, pacchetto di 100 pezzi

**Hämorrhoidal-Ligatoren**

*Haemorrhoidal ligators*

*Ligateurs hémorroïdales*

*Ligadores hemorroidales*

*Legatori emorroidali*



**RUDD**

1:2

	x = 12 mm Ø	x = 12 mm Ø
315 mm – 12 ½"	367-428-000	367-428-020

**komplett**  
 complete  
 complét  
 completa  
 completa

**Ladekegel allein**  
 Cone piece only  
 Cône seule  
 Cono sólo  
 Cono solo

**367-429-000**

**Gummiringe, Packung à 100 Stück**

Rubber rings, package of 100 pieces

Anneaux de caoutchouc à ligatures, paquet de 100 pièces

Anillos de goma para ligaduras, paquete de 100 piezas

Anelli di gomma, pacchetto di 100 pezzi