

09

Knochenchirurgie

Bone surgery

Chirurgie osseuse

Cirurgía ósea

Chirurgia ossea



Amputations- und Resektionssägen

Amputating and resection saws

Scies à amputation et résection
Sierra para amputación y resección
Seghe per amputazione



1:3

CHARRIÈRE

350 mm – 13 3/4"
71-220-350



12 mm	421-097-920
15 mm	421-097-950
18 mm	421-097-980

Ersatzsägeblätter
Spare saw blades
Lames de rechange
Hojas de cambio
Lame di ricambio



1:3

**HELFERICH-
BIER**

390 mm – 15 1/2"
71-230-390



3 mm	71-230-003
5 mm	71-230-005
7 mm	71-230-007

Ersatzsägeblätter
Spare saw blades
Lames de rechange
Hojas de cambio
Lame di ricambio

Amputations- und Resektionssägen
Amputating and resection saws

Scies à amputation et résection
Sierra para amputación y resección
Seghe per amputazione



1:2

SATTERLEE

290 mm – 11 ½"	71-212-290
----------------	------------

71-212-290/1

Ersatzsägeblatt
Spare saw blade
Lame de rechange
Hoja de cambio
Lame di ricambio



1:2

LANGENBECK

230 mm – 9"	71-200-230
-------------	------------



CHARRIÈRE

270 mm – 10 ¾"	71-208-270
300 mm – 12"	71-208-300
340 mm – 13 ½"	71-208-340

Raspeln, Feilen

Rasps, files

Râpes, limes

Escofinas, limas

Raspe, lime



PUTTI

270 mm – 10¾"	331-969-270	
300 mm – 12"		331-971-300

280 mm – 11"	
422-476-280	

halbrund
semicircular
semi-ronde
semi-redonda
semi-rotonda

245 mm – 9¾"	
x = 13 mm	
331-967-240	

halbrund
semicircular
semi-ronde
semi-redonda
semi-rotonda

220 mm – 8¾"	
x = 20 mm	
331-968-220	

flach
flat
plate
plana
piatta

Hämmer
Mallets
Maillets
Martillos
Martelli

DOYEN

	195 mm – 7 ¾ "
25 mm Ø – 120 g	66-624-120
30 mm Ø – 180 g	66-624-180
35 mm Ø – 260 g	66-624-260

COLLIN

	200 mm – 8 "
30 mm Ø – 220 g	66-630-220

1:2

HAJEK

	215 mm – 8 ½ "
27 mm Ø – 140 g	422-210-010

1:2

KIRK

	190 mm – 7 ½ "
38 mm Ø – 750 g	331-684-750

1:2

Hämmer
Mallets
Maillets
Martillos
Martelli



PARTSCH

1:2

	180 mm – 7 "
22 mm Ø – 200 g	66-648-200



LUCAE

	190 mm – 7 ½ "
19 mm Ø – 230 g	331-692-230
25 mm Ø – 260 g	331-692-260

Hämmer
Mallets
Maillets
Martillos
Martelli



1:2

BERGMANN

245 mm – 9¾"
45 mm Ø – 300 g
66-654-300



1:2

OMBREDANNE

240 cm – 9½"
40 mm Ø – 550 g
66-658-230

HEATH

40 mm Ø – 700 g	185 mm – 7⅓"	66-656-185
45 mm Ø – 1000 g	200 mm – 8"	66-656-200

Kupferfüllung
 Copper filled head
 Rempli de cuivre
 Llenado de cobre
 Riempito di rame

Hämmer
Mallets
Maillets
Martillos
Martelli



1:2

190 mm – 7 ½"
250 mm Ø – 205 g
331-687-140

Massiver Stahl, mit Kunststoffbacken
 Solid steel, with plastic faces
 Acier solid, avec plaques en plastique
 Acero sólido, con placas en plástico
 Acciaio massiccio, con punte di plastica

331-687-990

Ersatzbacken, 1 Paar
 Spare faces, 1 pair
 Plaques de rechange, 1 paire
 Placas de cambio, 1 par
 Punte di ricambio, 1 paio



1:2

COTTLE	240 g
185 mm – 7 ¼"	66-620-185

1 Seite flach / 1 Seite convex
 1 side flat / 1 side convex
 1 coté plat / 1 coté convexe
 1 lato piano / 1 lato convesso
 1 lato piatto / 1 lato convesso



WILLIGER	240 mm – 9 ½"
26 mm Ø – 300 g	422-196-010
28 mm Ø – 340 g	422-196-020
30 mm Ø – 400 g	422-196-030

bleigefüllt
 lead filled
 rempli de plomb
 llenado con plomo
 riempito di piombo

Hämmer
Mallets
Maillets
Martillos
Martelli



1:2

165 mm – 6 ½"
20 mm Ø – 150 g
66-660-150



1:2

MEAD

170 mm – 6 ¾"
26 mm Ø – 320 g
66-642-320

Stahl massiv, mit Kunststoffbacken
Steel solid, with plastic faces
Acier solid, avec plaques en plastique
Acero sólido, con placas en plástico
Acciaio massiccio, con punte di plastica

66-644-000

Ersatzbacken, 1 Paar
Spare faces, 1 pair
Plaques de rechange, 1 paire
Placas de cambio, 1 par
Punte di ricambio, 1 paio

Hämmer
Mallets
Maillets
Martillos
Martelli



1:2

225 mm – 8 ¾"
37 mm Ø – 370 g
422-250-220

Kopf massiver Stahl, mit Ferrozellbacken
Head solid steel, with Ferrozell faces
Tête acier solid, avec plaques en Ferrozell
Cabeza acero sólido, con placas en Ferrozell
Testa acciaio massiccio, con punte di Ferrozell

422-251-000

Ersatzbacken, 1 Paar
Spare faces, 1 pair
Plaques de rechange, 1 paire
Placas de cambio, 1 par
Punte di ricambio, 1 paio



1:2

240 mm – 9 ½"
30 mm Ø – 480 g
422-240-240

Kopf massiver Stahl, mit Ferrozellbacken
Head solid steel, with Ferrozell faces
Tête acier solid, avec plaques en Ferrozell
Cabeza acero sólido, con placas en Ferrozell
Testa acciaio massiccio, con punte di Ferrozell

Hämmer
Mallets
Maillets
Martillos
Martelli



1:2

	42 mm Ø – 250 g	42 mm Ø – 400 g
260 mm – 10 ¼"	331-694-250	331-694-400

Ferrozell, ohne Blei
 Ferrozell, without lead
 Ferrozell, sans plomb
 Ferrozell, sin plomo
 Ferrozell, senza piombo

Kunststoff, bleigefüllt
 Plastic, lead filled
 Matière plastique, rempli de plomb
 Plástico, llenado con plomo
 Plastica, riempito di piombo



1:2

	30 mm Ø – 450 g	50 mm Ø – 900 g
265 mm – 10 ½"	331-686-450	331-686-900

Knochenmeißel

Bone chisels and gouges

Ciseaux-burins, gouges

Cinceles, gubias

Scalpelli, sgorbi

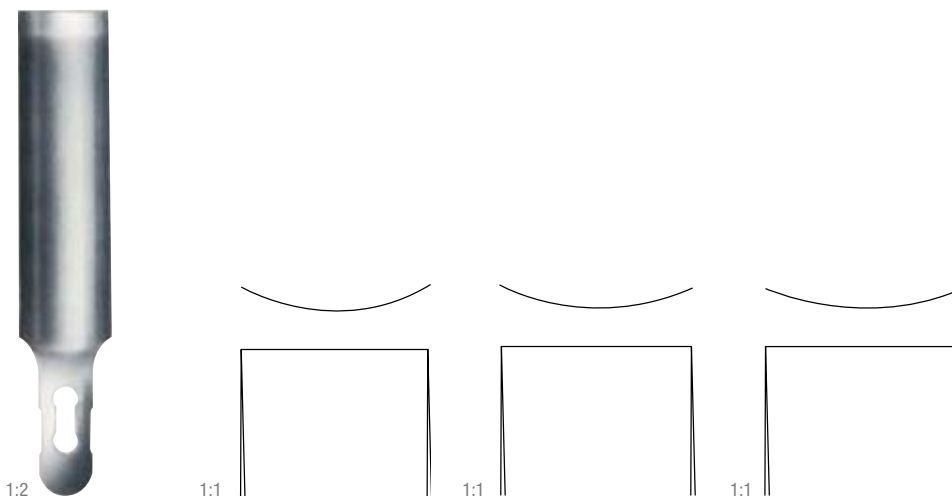

	25 mm (r = 50 mm)	25 mm (r = 60 mm)	25 mm (r = 70 mm)
135 mm – 5¼"	331-577-500	331-577-600	331-577-700

Hohlmeißelklingen, auswechselbar

Gouge blades, interchangeable
 Lames gouges, interchangeables
 Hojas de gubia, intercambiables
 Lame intercambiabili, concavo

Knochenmeißel
Bone chisels and gouges
Ciseaux-burins, gouges
Cinceles, gubias
Scalpelli, sgorbi

1:2

185 mm – 7 ¼"

331-576-000

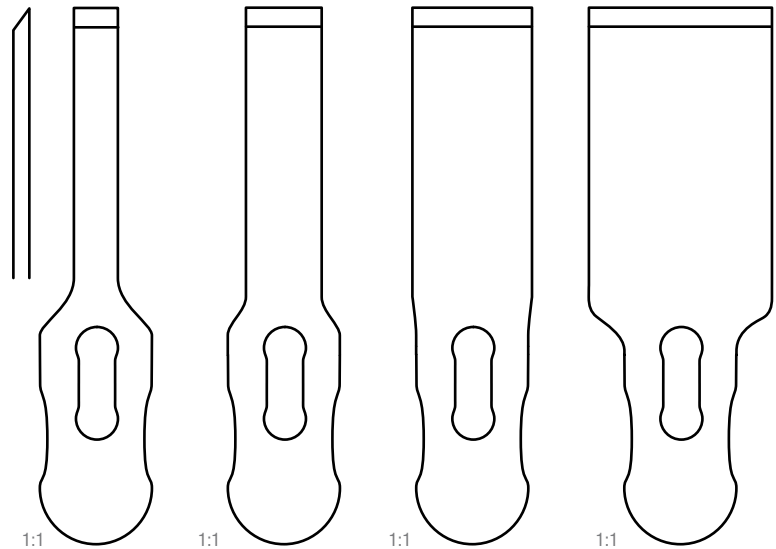

	5 mm	10 mm	16 mm	25 mm
85 mm – 3 ¼"	331-576-050	331-576-100	331-576-160	331-576-250

Meißelklingen, auswechselbar

Chisel blades, interchangeable

Lames ciseaux-burin, interchangeables

Hojas de cincel, intercambiables

Lame, intercambiabili

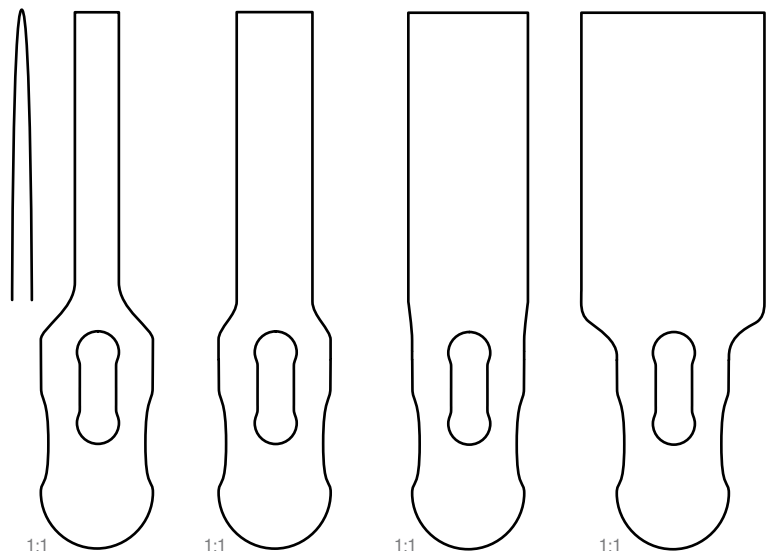

	5 mm	10 mm	16 mm	25 mm
85 mm – 3 ¼"	331-576-005	331-576-010	331-576-016	331-576-025

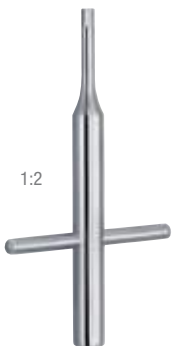

1:2

90 mm – 3 ½"

331-576-990

Spannschlüssel

Key

Clé

Llave

Chiave

Osteotomklingen, auswechselbar

Osteotome blades, interchangeable

Lames d'osteotomos interchangeables

Hojas de osteótomo, intercambiables

Lame per osteotomia, intercambiabili

Knochenmeißel

Bone chisels and gouges

Ciseaux-burins, gouges

Cinceles, gubias

Scalpelli, sgorbi

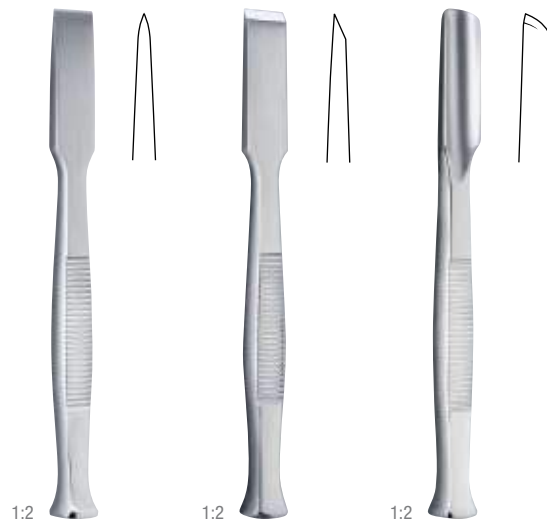

	135 mm – 5 ¼"	135 mm – 5 ¼"	135 mm – 5 ¼"
4 mm			66-504-004
6 mm	66-500-006	66-502-006	66-504-006
8 mm	66-500-008	66-502-008	66-504-008
10 mm	66-500-010	66-502-010	66-504-010
12 mm	66-500-012	66-502-012	66-504-012
14 mm	66-500-014	66-502-014	66-504-014
16 mm	66-500-016	66-502-016	66-504-016

Knochenmeißel
Bone chisels and gouges
Ciseaux-burins, gouges
Cinceles, gubias
Scalpelli, sgorbi

ALEXANDER

	180 mm – 7"	180 mm – 7"
4 mm	66-520-004	66-522-004
6 mm	66-520-006	66-522-006
8 mm	66-520-008	66-522-008
10 mm	66-520-010	66-522-010
12 mm	66-520-012	66-522-012
14 mm	66-520-014	66-522-014

LUCAS

	160 mm – 6¼"	160 mm – 6¼"
3 mm		66-532-003
4 mm	66-530-004	
6 mm	66-530-006	66-532-006

Flachmeißel
 Chisel
 Ciseau burin
 Cincel
 Scalpello

Hohlmeißel
 Gouge
 Gouge
 Gubia
 Sgorbi

Knochenchirurgie

Bone surgery

09

Knochenmeißel

Bone chisels and gouges

Ciseaux-burins, gouges

Cinceles, gubias

Scalpelli, sgorbi



PARTSCH

	115 mm – 4½"	135 mm – 5¼"	170 mm – 6¾"
2 mm	422-100-020	66-510-002	331-618-020
3 mm	422-100-030	66-510-003	331-618-030
4 mm	422-100-040	66-510-004	331-618-040
5 mm	422-100-050	66-510-005	331-618-050
6 mm	422-100-060	66-510-006	331-618-060
7 mm	422-100-070	66-510-007	331-618-070
8 mm	422-100-080	66-510-008	331-618-080

	115 mm – 4½"	135 mm – 5¼"	170 mm – 6¾"
	422-104-020	66-512-002	331-621-020
	422-104-030	66-512-003	331-621-030
	422-104-040	66-512-004	331-621-040
	422-104-050	66-512-005	331-621-050
	422-104-060	66-512-006	331-621-060
	422-104-070	66-512-007	331-621-070
	422-104-080	66-512-008	331-621-080

Knochenmeißel
Bone chisels and gouges
Ciseaux-burins, gouges
Cinceles, gubias
Scalpelli, sgorbi

LAMBOTTE

1:2

1:2

	250 mm – 9¾"	250 mm – 9¾"
4 mm	66-550-004	66-551-004
6 mm	66-550-006	66-551-006
8 mm	66-550-008	66-551-008
10 mm	66-550-010	66-551-010
13 mm	66-550-013	66-551-013
15 mm	66-550-015	66-551-015
20 mm	66-550-020	66-551-020
25 mm	66-550-025	66-551-025
30 mm	66-550-030	66-551-030
38 mm	66-550-038	66-551-038
44 mm	66-550-044	66-551-044
50 mm	66-550-050	66-551-050

MINI-LAMBOTTE

	125 mm – 5"	170 mm – 6¾"
3 mm	331-650-030	422-132-530
4 mm	331-650-040	422-132-540
6 mm	331-650-060	422-132-560
8 mm	331-650-080	422-132-580
10 mm	331-650-100	422-132-600
12 mm	331-650-120	422-132-620
14 mm	331-650-140	
15 mm	331-650-150	422-132-650
18 mm	331-650-180	
20 mm	331-650-200	

Knochenmeißel
Bone chisels and gouges
Ciseaux-burins, gouges
Cinceles, gubias
Scalpelli, sgorbi



LEXER

1:2

1:2

	220 mm – 8 3/4"	220 mm – 8 3/4"
5 mm	66-540-005	66-542-005
7 mm	66-540-007	66-542-007
10 mm	66-540-010	66-542-010
15 mm	66-540-015	66-542-015
20 mm	66-540-020	66-542-020
25 mm	66-540-025	66-542-025
30 mm	66-540-030	66-542-030

Ferrozellgriff
 Ferrozell handle
 Manche en Ferrozell
 Mango en Ferrozell
 Manico di Ferrozell



MINI-LEXER

1:2

1:2

	180 mm – 7"	180 mm – 7"
4 mm	331-660-040	331-661-040
6 mm	331-660-060	331-661-060
8 mm	331-660-080	331-661-080
10 mm	331-660-100	331-661-100
12 mm	331-660-120	331-661-120

Ferrozellgriff
 Ferrozell handle
 Manche en Ferrozell
 Mango en Ferrozell
 Manico di Ferrozell

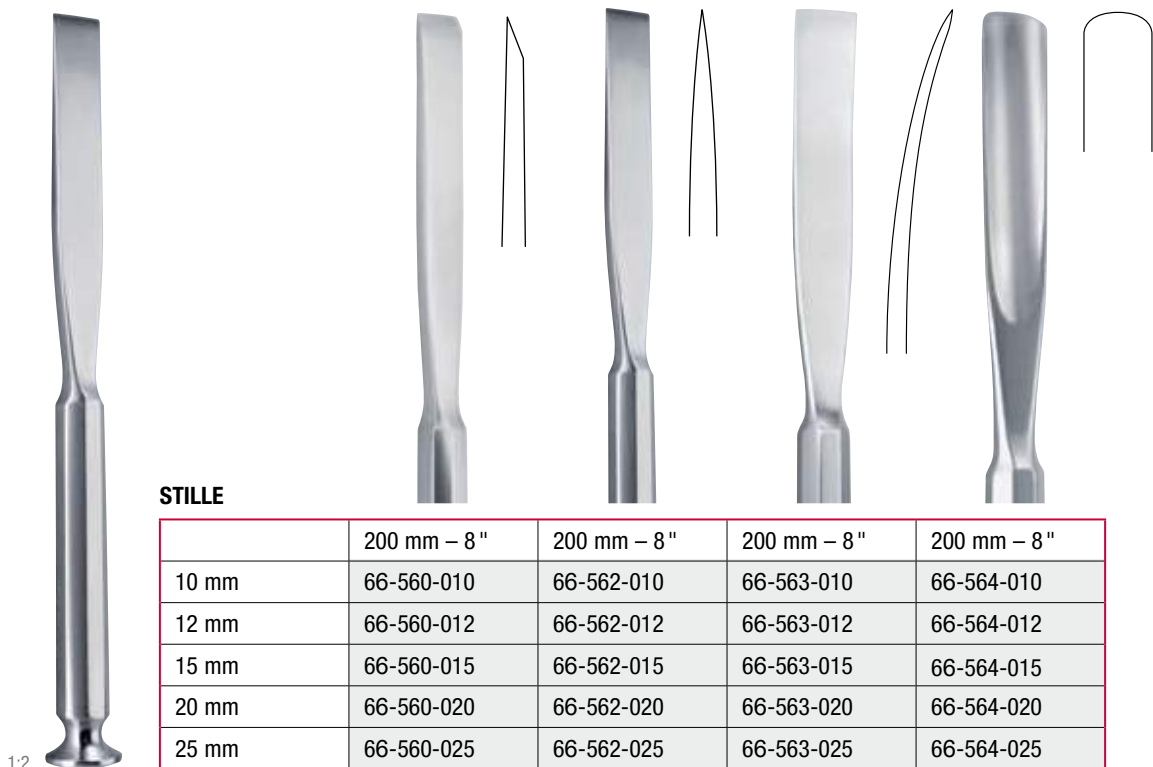
Knochenmeißel
Bone chisels and gouges
Ciseaux-burins, gouges
Cinceles, gubias
Scalpelli, sgorbi

STILLE

	200 mm – 8"	200 mm – 8"	200 mm – 8"	200 mm – 8"
10 mm	66-560-010	66-562-010	66-563-010	66-564-010
12 mm	66-560-012	66-562-012	66-563-012	66-564-012
15 mm	66-560-015	66-562-015	66-563-015	66-564-015
20 mm	66-560-020	66-562-020	66-563-020	66-564-020
25 mm	66-560-025	66-562-025	66-563-025	66-564-025

1:2

Knochenchirurgie

Bone surgery

Knochenmeißel
Bone chisels and gouges
Ciseaux-burins, gouges
Cinceles, gubias
Scalpelli, sgorbi

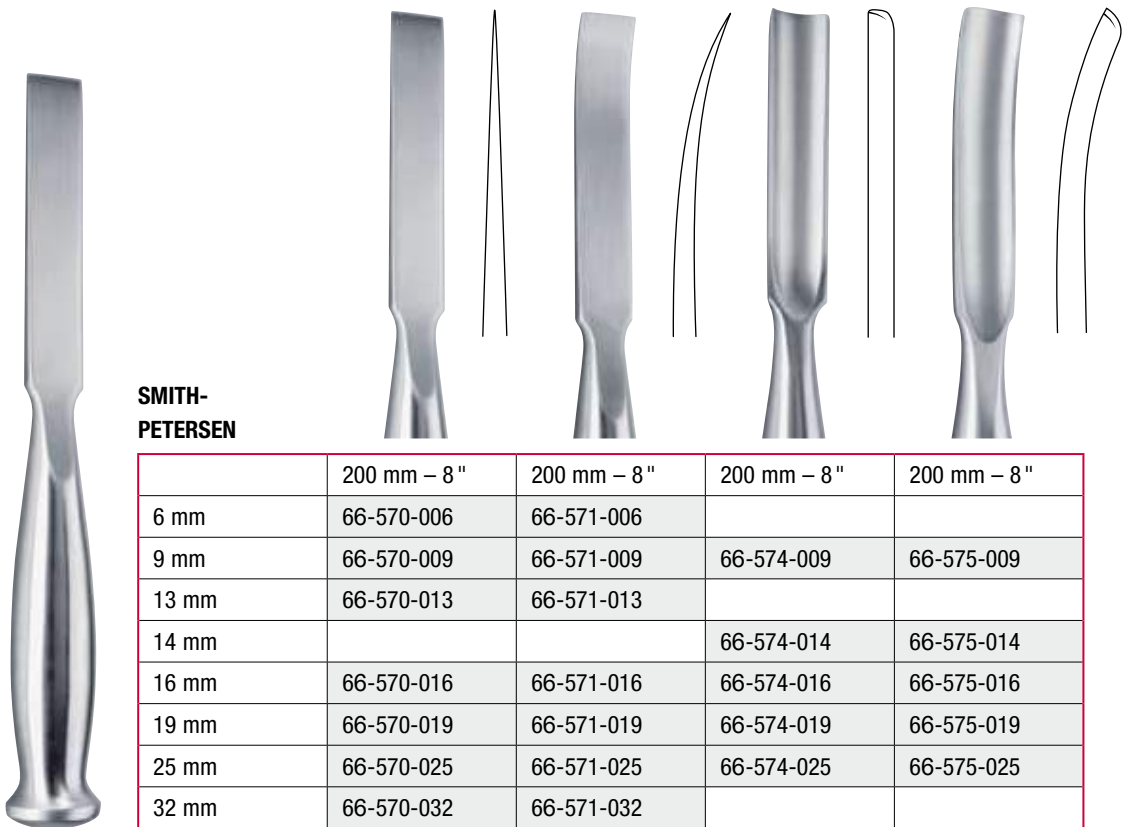

**SMITH-
PETERSEN**

	200 mm – 8 "	200 mm – 8 "	200 mm – 8 "	200 mm – 8 "
6 mm	66-570-006	66-571-006		
9 mm	66-570-009	66-571-009	66-574-009	66-575-009
13 mm	66-570-013	66-571-013		
14 mm			66-574-014	66-575-014
16 mm	66-570-016	66-571-016	66-574-016	66-575-016
19 mm	66-570-019	66-571-019	66-574-019	66-575-019
25 mm	66-570-025	66-571-025	66-574-025	66-575-025
32 mm	66-570-032	66-571-032		

1:2

Knochenmeißel
Bone chisels and gouges
Ciseaux-burins, gouges
Cinceles, gubias
Scalpelli, sgorbi

HIBBS

	240 mm – 9 ½"	240 mm – 9 ½"	240 mm – 9 ½"	240 mm – 9 ½"	240 mm – 9 ½"
6 mm	66-582-006	66-580-006	66-583-006	66-586-006	66-587-006
9 mm	66-582-009		66-583-009	66-586-009	66-587-009
13 mm	66-582-013	66-580-013	66-583-013	66-586-013	66-587-013
16 mm	66-582-016		66-583-016	66-586-016	66-587-016
19 mm	66-582-019	66-580-019	66-583-019	66-586-019	66-587-019
25 mm	66-582-025	66-580-025	66-583-025	66-586-025	66-587-025
32 mm	66-582-032	66-580-032	66-583-032	66-586-032	66-587-032

1:2

Knochenmeißel

Bone chisels and gouges

Ciseaux-burins, gouges
Cinceles, gubias
Scalpelli, sgorbi

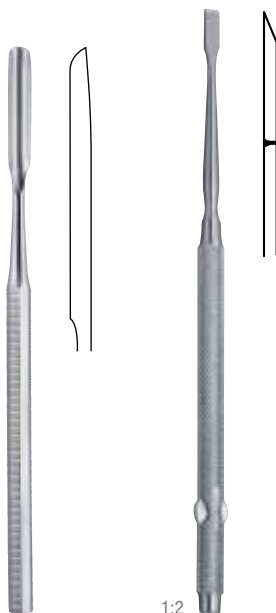

FREER

1:2

1:2

	150 mm – 6"	160 mm – 6 ¼"
6 mm	45-528-006	
4 mm		45-520-004

Hohlmeißel
Gouge
Gouge
Gubia
Sgorbi

Flachmeißel
Chisel
Ciseau burin
Cinzel
Scalpello

BALLENGER

1:2



	160 mm – 6 ¼"
4 mm	345-480-040
6 mm	345-480-060
8 mm	345-480-080



1:2

**MANNERFELT
MODIF.**

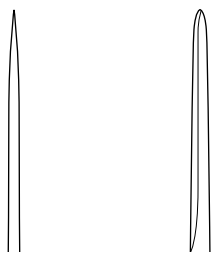

	155 mm – 6"	155 mm – 6"
3 mm		66-462-003
4 mm	66-460-004	
6 mm	66-460-006	
8 mm	66-460-008	

Osteotome
Osteotomes
Ostéotomes
Osteótomos
Osteotomi

Hohlmeißel
Gouge
Gouge
Gubia
Sgorbi

Meißel zur Nasenplastik
Chisels, osteotomes for rhinoplasty
Ostéotomes, ciseaux-burins pour rhinoplastique
Cinceles para rinoplastia
Scalpelli per plastica nasale

1:2

KILIAN

160 mm – 6 ¼"
5 mm
45-541-005



1:2

KILIAN-CLAUS

160 mm – 6 ¼"
5 mm
45-551-005

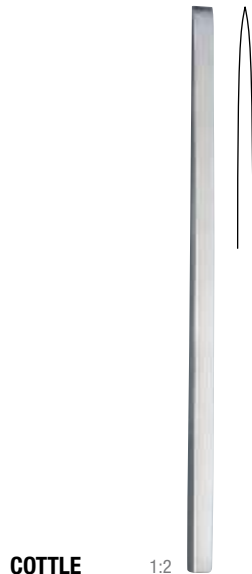

1:2

COTTLE

	150 mm – 6"
7 mm	45-570-007
9 mm	45-570-009
12 mm	45-570-012

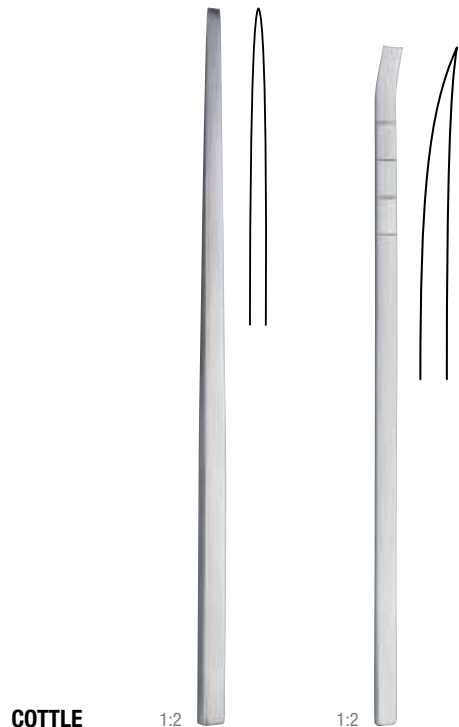
COTTLE

1:2

1:2

	190 mm – 7 ½"	180 mm – 7"
4 mm	45-574-004	
6 mm		45-577-006

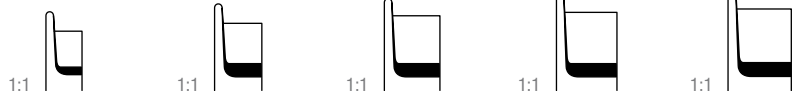

1:2

FOMON

	4 mm	5 mm	6 mm	7 mm	8 mm
170 mm – 6 ¾"	45-584-004	45-584-005	45-584-006	45-584-007	45-584-008

Knochenchirurgie

Bone surgery

Meißel zur Nasenplastik

Chisels, osteotomes for rhinoplasty

Ostéotomes, ciseaux-burins pour rhinoplastique
Cinceles para rinoplastia
Scalpelli per plastica nasale



1:2

CINELLI

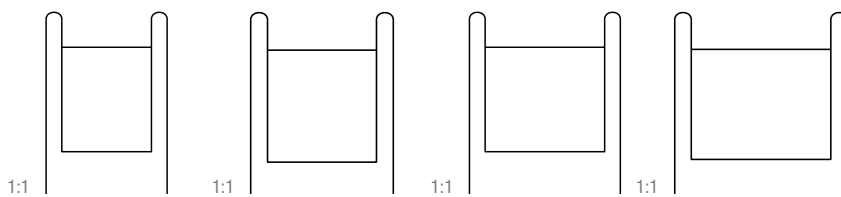

	10 mm	12 mm	14 mm	16 mm
180 mm – 7"	345-468-100	345-468-120	345-468-140	345-468-160



1:2

COTTLE

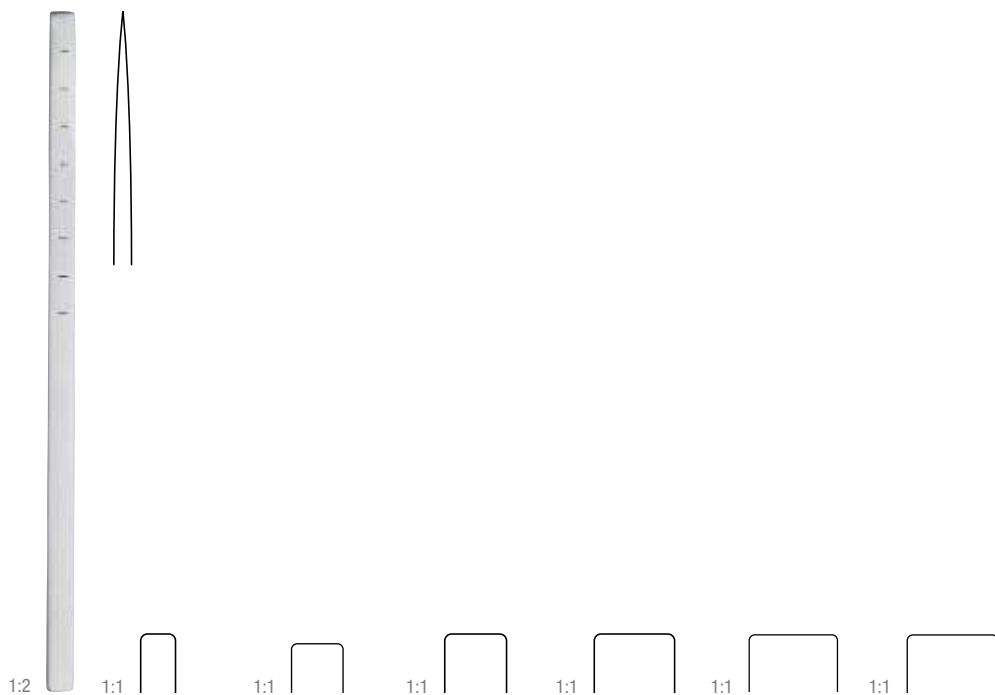

	4 mm	6 mm	7 mm	9 mm	10 mm	12 mm
180 mm – 7"	345-450-040	345-450-060	345-450-070	345-450-090	345-450-100	345-450-120

COTTLE



	4 mm	7 mm	9 mm	12 mm
180 mm – 7"	345-454-040	345-454-070	345-454-090	345-454-120

Meißel zur Nasenplastik

Chisels, osteotomes for rhinoplasty

Ostéotomes, ciseaux-burins pour rhinoplastique

Cinceles para rinoplastia

Scalpelli per plastica nasale

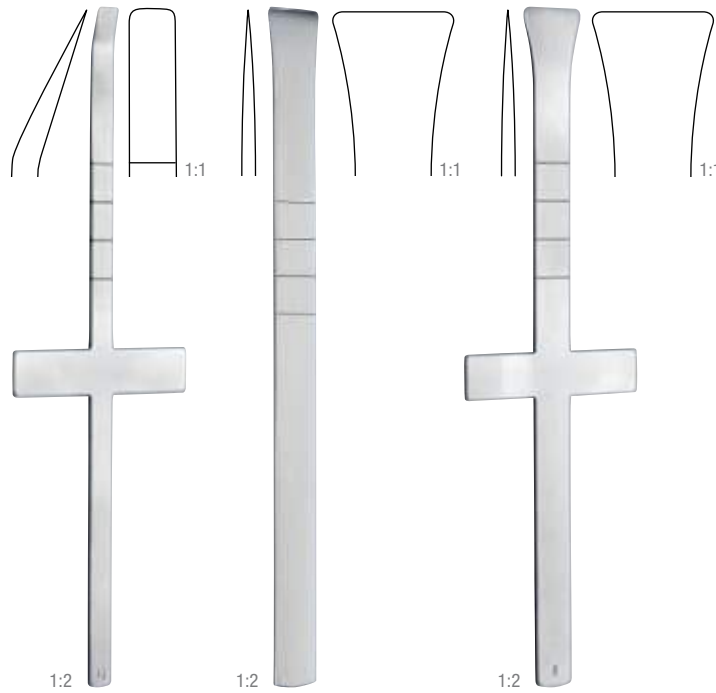

COTTLE

	6 mm	16 mm	16 mm
180 mm – 7"	436-605-060	436-606-160	436-608-160



RUBIN



	10 mm	12 mm	14 mm
180 mm – 7"	436-612-100	436-612-120	436-612-140

Meißel zur Nasenplastik

Chisels, osteotomes for rhinoplasty

Ostéotomes, ciseaux-burins pour rhinoplastique

Cinceles para rinoplastia

Scalpelli per plastica nasale



WALTER



	3 mm	4.5 mm
190 mm – 7 ½"	436-616-030	436-616-040

1:2



SHEEHAN

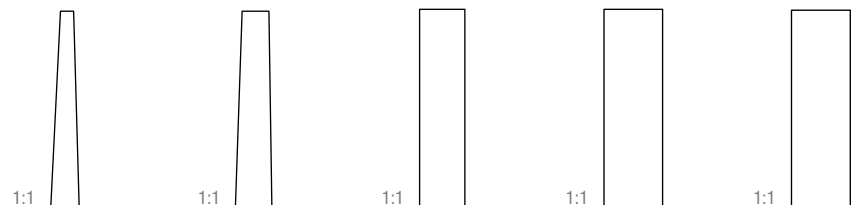

	2 mm	4 mm	6 mm	7 mm	8 mm
160 mm – 6 ¼"	436-622-020	436-622-040	436-622-060	436-622-070	436-622-080

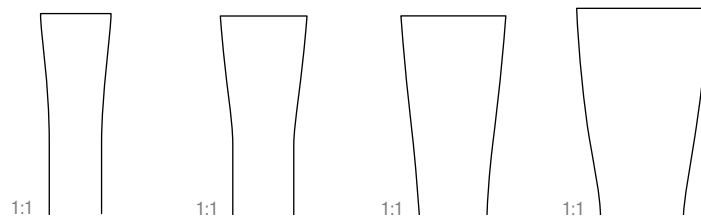

10 mm	12 mm	15 mm	18 mm
436-622-100	436-622-120	436-622-150	436-622-180

1:2

Meißel zur Nasenplastik
Chisels, osteotomes for rhinoplasty
Ostéotomes, ciseaux-burins pour rhinoplastique
Cinceles para rinoplastia
Scalpelli per plastica nasale

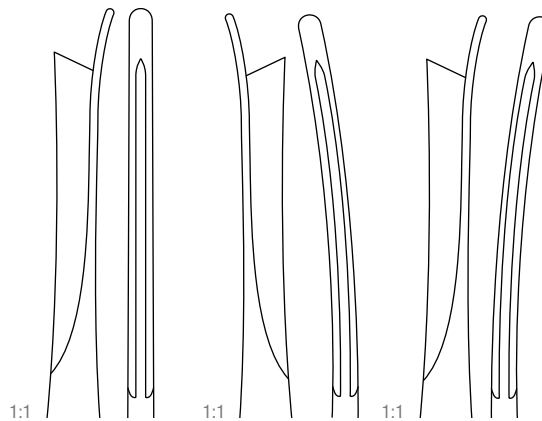
SILVER

180 mm – 7"	345-469-010	345-469-020	345-469-030
-------------	-------------	-------------	-------------

gerade
 straight
 droit
 recta
 retta

rechts
 right
 droite
 derecha
 destra

links
 left
 gauche
 izquierda
 sinistra

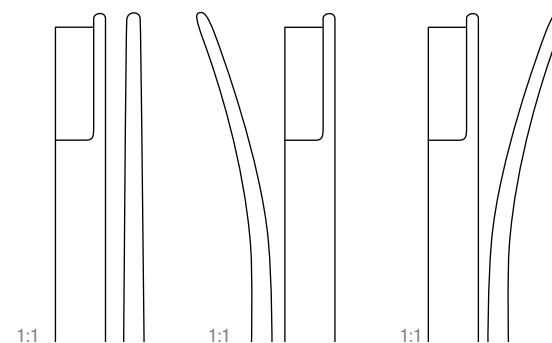
NEIVERT-ANDERSON

200 mm – 8"	345-471-010	345-471-020	345-471-030
-------------	-------------	-------------	-------------

gerade
 straight
 droit
 recta
 retta

rechts
 right
 droite
 derecha
 destra

links
 left
 gauche
 izquierda
 sinistra

Meißel für die Kieferchirurgie

Osteotomes for maxillo-facial surgery

Ostéotomes pour la chirurgie maxillo-faciale

Cinceles para la cirugía maxilofacial

Scalpelli per chirurgia massilofaciale

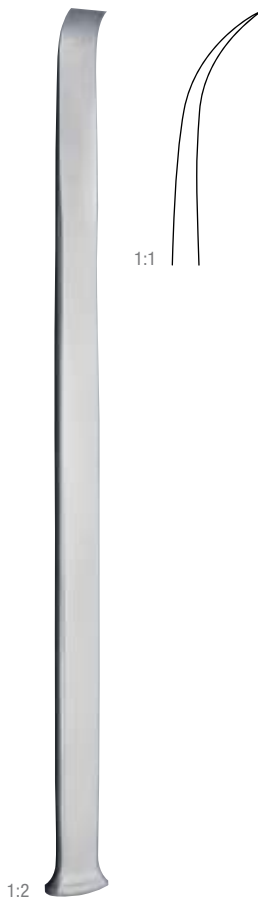

1:2

OBWEGESER

	8 mm	11 mm	13 mm
235 mm – 9¼"	347-622-080	347-622-110	347-622-240



OBWEGESER

1:2

1:2

	7 mm	10 mm
215 mm – 8½"	347-620-007	347-620-010

Stößel
Tampers
Pilons
Punzones
Pestoni



1:2

1:1 ○

1:1 ○

1:1 ○

1:1 ○

1:1 ○

1:1 ○

1:1 ○

	2 mm Ø	3 mm Ø	4 mm Ø	5 mm Ø	6 mm Ø	8 mm Ø	10 mm Ø
155 mm – 6"	331-578-020	331-578-030	331-578-040	331-578-050	331-578-060	331-578-080	331-578-100



1:2

PASSOW

1:1 □

1:1 □

1:1 □

	Fig. 1	Fig. 2	Fig. 3
	2.5 mm x 2.5 mm	3.5 mm x 3.5 mm	4.5 mm x 4.5 mm
120 mm – 4 ¾"	66-594-001	66-594-002	66-594-003



1:2



1:2

CASPAR

1:1 ●

1:1 ●

1:1 ●

	3 mm Ø	5 mm Ø	8 mm Ø
200 mm – 8"	331-580-030	331-580-050	331-580-080

1:1

1:1

1:1

	12 mm Ø	14 mm Ø	16 mm Ø
200 mm – 8"	331-582-120	331-582-140	331-582-160

Scharfe Löffel

Bone curettes

Curettes tranchantes

Cucharillas cortantes

Cucchiai taglienti



1:2

VOLKMANN

1:1

1:1

1:1

1:1

1:1

	Fig. 0000	Fig. 000	Fig. 00	Fig. 0	Fig. 1
170 mm – 6¾"	66-724-000	66-724-001	66-724-002	66-724-003	66-724-010

1:1

1:1

1:1

1:1

1:1

Fig. 2	Fig. 3	Fig. 4	Fig. 5	Fig. 6
66-724-020	66-724-030	66-724-040	66-724-050	66-724-060



1:2

SCHUDE

1:1

1:1

1:1

1:1

1:1

	Fig. 000	Fig. 00	Fig. 0	Fig. 1	Fig. 2
170 mm – 6¾"	66-720-001	66-720-002	66-720-003	66-720-010	66-720-020

1:1

1:1

Fig. 3	Fig. 4
66-720-030	66-720-040

Scharfe Löffel
Bone curettes

Curettes tranchantes
Cucharillas cortantes
Cucchiai taglienti



SPRATT

1:1



1:1



1:1



	Fig. 0000	Fig. 000	Fig. 00
170 mm – 6 3/4"	66-732-004	66-732-001	66-732-002

1:1



1:1



1:1



Fig. 0	Fig. 1	Fig. 2
66-732-003	66-732-010	66-732-020

1:1



1:1



1:1



Fig. 3	Fig. 4	Fig. 5
66-732-030	66-732-040	66-732-050

1:2

BRUNS

1:1



1:1



1:1



	Fig. 000	Fig. 00	Fig. 0
160 mm – 6 1/4"	66-728-001	66-728-002	66-728-003

1:1



1:1



1:1



Fig. 1	Fig. 2	Fig. 3
66-728-010	66-728-020	66-728-030

1:1



1:1



1:1



Fig. 4	Fig. 5	Fig. 6
66-728-040	66-728-050	66-728-060

1:2



Scharfe Löffel
Bone curettes

Curettes tranchantes
Cucharillas cortantes
Cucchiai taglienti

VOLKMANN

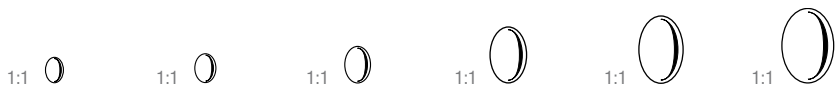

	Fig. 0000	Fig. 000	Fig. 00	Fig. 0	Fig. 1	Fig. 2
185 mm – 7 ¼"	422-276-400	422-276-300	422-276-200	422-276-100	422-276-010	422-276-020

oval, mit Kunststoffgriff
oval, with plastic handle
ovale, avec manche en matière plastique
ovalada, con mango plástico
ovale, con manico in plastica



	Fig. 3	Fig. 4	Fig. 5	Fig. 6
190 mm – 7 ½"	422-276-030	422-276-040	422-276-050	422-276-060

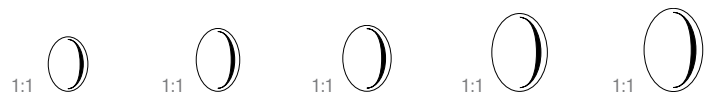

	Fig. 0	Fig. 1	Fig. 2	Fig. 3	Fig. 4
275 mm – 10 ¾"	422-278-100	422-278-010	422-278-020	422-278-030	422-278-040

Scharfe Löffel
Bone curettes
Curettes tranchantes
Cucharillas cortantes
Cucchiai taglienti

1:2

HALLÉ

	Fig. 1	Fig. 2	Fig. 3
210 mm – 8 ¼"	66-750-010	66-750-020	66-750-030

flexibel
 flexible
 flexible
 flexible
 flessibile

UFFENORDE

	Fig. 1	Fig. 2
170 mm – 6 ¾"	381-837-001	381-837-002

Scharfe Löffel
Bone curettes

Curettes tranchantes
Cucharillas cortantes
Cucchiai taglienti

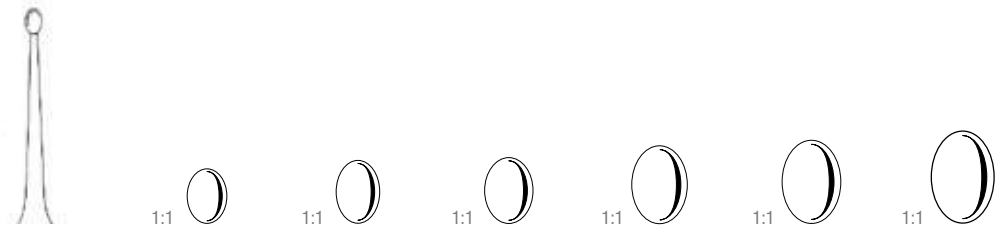

	Fig. 1	Fig. 2	Fig. 3	Fig. 4	Fig. 5	Fig. 6
160 mm – 6¼"	381-840-010	381-840-020	381-840-030	381-840-040	381-840-050	381-840-060

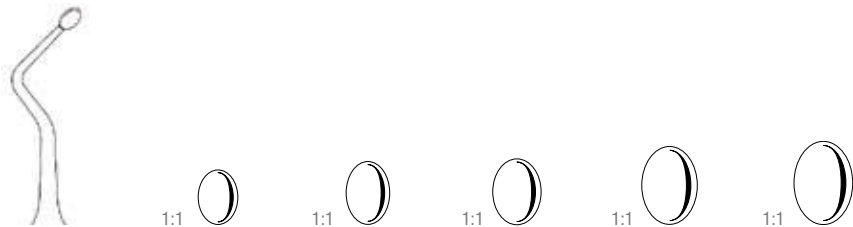

	Fig. 1	Fig. 2	Fig. 3	Fig. 4	Fig. 5
160 mm – 6¼"	381-843-010	381-843-020	381-843-030	381-843-040	381-843-060

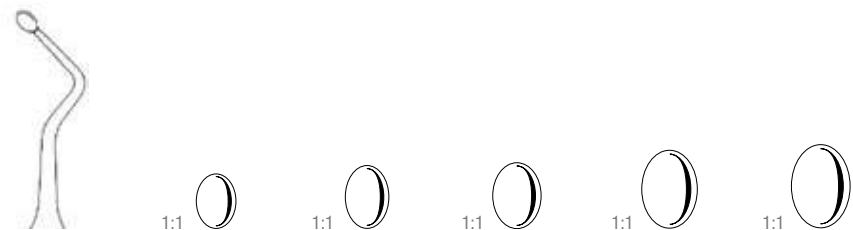

	Fig. 1	Fig. 2	Fig. 3	Fig. 4	Fig. 5
160 mm – 6¼"	381-841-010	381-841-020	381-841-030	381-841-040	381-841-060

Scharfe Löffel
Bone curettes
Curettes tranchantes
Cucharillas cortantes
Cucchiai taglienti
BRUNS

		Fig. 00	Fig. 0	Fig. 1	Fig. 2
230 mm – 9"	gerade straight droit recta retto	66-738-002	66-738-003	66-738-010	66-738-020
230 mm – 9"	gebogen curved courbe curva curvo	66-739-002	66-739-003	66-739-010	66-739-020

massiv
 solid
 solide
 macizo
 massiccio

1:2

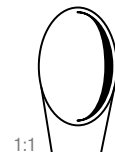

		Fig. 3	Fig. 4	Fig. 5	Fig. 6
230 mm – 9"	gerade straight droit recta retto	66-738-030	66-738-040	66-738-050	66-738-060
230 mm – 9"	gebogen curved courbe curva curvo	66-739-030	66-739-040	66-739-050	66-739-060

massiv
 solid
 solide
 macizo
 massiccio

Scharfe Löffel
Bone curettes

Curettes tranchantes
Cucharillas cortantes
Cucchiai taglienti



1:2

SCHROEDER

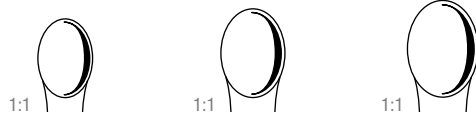

	Fig. 1	Fig. 2	Fig. 3
300 mm – 12"	61-612-001	61-612-002	61-612-003

scharf / fest
sharp / rigid
tranchante / rigide
cortante / rigida
tagliente / rigido

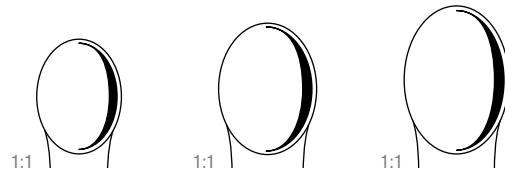

Fig. 4	Fig. 5	Fig. 6
61-612-004	61-612-005	61-612-006

SIMON



	Fig. 1	Fig. 2	Fig. 3	Fig. 4	Fig. 5	Fig. 6
240 mm – 9½"	66-744-010	66-744-020	66-744-030	66-744-040	66-744-050	66-744-060

scharf / fest
sharp / rigid
tranchante / rigide
cortante / rigida
tagliente / rigido



1:2

SIMON



	Fig. 1	Fig. 2	Fig. 3
250 mm – 9¾"	61-610-001	61-610-002	61-610-003

scharf / fest
sharp / rigid
tranchante / rigide
cortante / rigida
tagliente / rigido

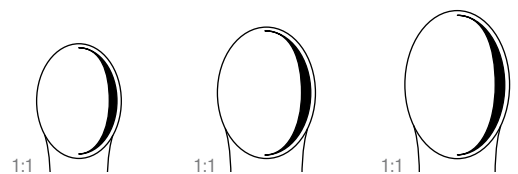











Fig. 4	Fig. 5	Fig. 6
61-610-004	61-610-005	61-610-006

Scharfe Löffel
Bone curettes
Curettes tranchantes
Cucharillas cortantes
Cucchiai taglienti

1:2





				
	1:1	1:1	1:1	1:1
	Fig. 000	Fig. 00	Fig. 0	Fig. 1
	3.6 mm	4.4 mm	5.2 mm	6.8 mm
250 mm – 9¾"	331-506-360	331-506-440	331-506-520	331-506-600

gerade
 straight
 droit
 recta
 retto

				
1:1	1:1	1:1	1:1	
	Fig. 000	Fig. 00	Fig. 0	Fig. 1
	3.6 mm	4.4 mm	5.2 mm	6.8 mm
250 mm – 9¾"	331-507-360	331-507-440	331-507-520	331-507-600

gebogen
 curved
 courbe
 curva
 curvo

1:2

				
	1:1	1:1	1:1	1:1
DAUBENSPECK	Fig. 00	Fig. 0	Fig. 1	Fig. 2
	2.8 mm	3.6 mm	4.4 mm	5.2 mm
200 mm – 8"	331-482-990	331-483-000	331-483-010	331-483-020

Scharfe Löffel
Bone curettes

Curettes tranchantes
Cucharillas cortantes
Cucchiai taglienti



1:2
SCOVILLE



	Fig. 1	Fig. 2	Fig. 3
250 mm – 9¾"	381-822-250	381-833-250	381-835-250

oval
 oval
 ovale
 ovalada
 ovale

1:2
LEMPERT

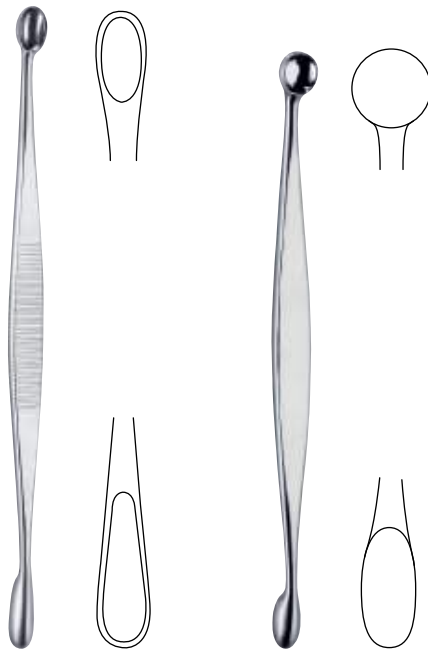

	Fig. 00000	Fig. 0000	Fig. 000	Fig. 00	Fig. 0
	1.8 mm	2.0 mm	2.4 mm	2.6 mm	2.8 mm
215 mm – 8½"	331-486-500	331-486-400	331-486-300	331-486-200	331-486-100

Scharfe Doppellöffel
Bone curettes, double-ended
Curettes doubles
Cucharillas de doble extremo
Curette doppia

VOLKMANN

130 mm – 5"	66-770-130	66-774-130
140 mm – 5½"	66-770-140	
160 mm – 6¼"		66-774-160
170 mm – 6¾"	66-770-170	
200 mm – 8"		66-774-200

oval / oval
 oval / oval
 ovale / ovale
 ovalada / ovalada
 ovale / ovale

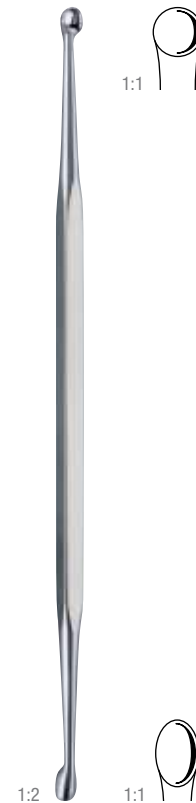
rund / oval
 round / oval
 ronde / ovale
 redonda / ovalada
 rotondo / ovale



210 mm – 8¼"	331-498-210
--------------	-------------

rund / oval
 round / oval
 ronde / ovale
 redonda / ovalada
 rotondo / ovale

Scharfe Doppellöffel
Bone curettes, double-ended
Curettes doubles
Cucharillas de doble extremo
Curette doppie



MARTINI

	Fig. 00	Fig. 0	Fig. 1
	Fig. 0	Fig. 1	Fig. 2
135 mm – 5 ¼"	66-794-000	66-794-001	66-794-012



MARTINI

	Fig. 00	Fig. 0	Fig. 1
	Fig. 0	Fig. 1	Fig. 2
155 mm – 6"	381-859-000	381-859-100	381-859-110



WILLIGER

	Fig. 00	Fig. 0	Fig. 1
	Fig. 0	Fig. 1	Fig. 2
135 mm – 5 ¼"	66-790-000	66-790-001	66-790-012



WILLIGER

	Fig. 00	Fig. 0	Fig. 1
	Fig. 0	Fig. 1	Fig. 2
155 mm – 6"	381-855-000	381-855-100	381-855-110

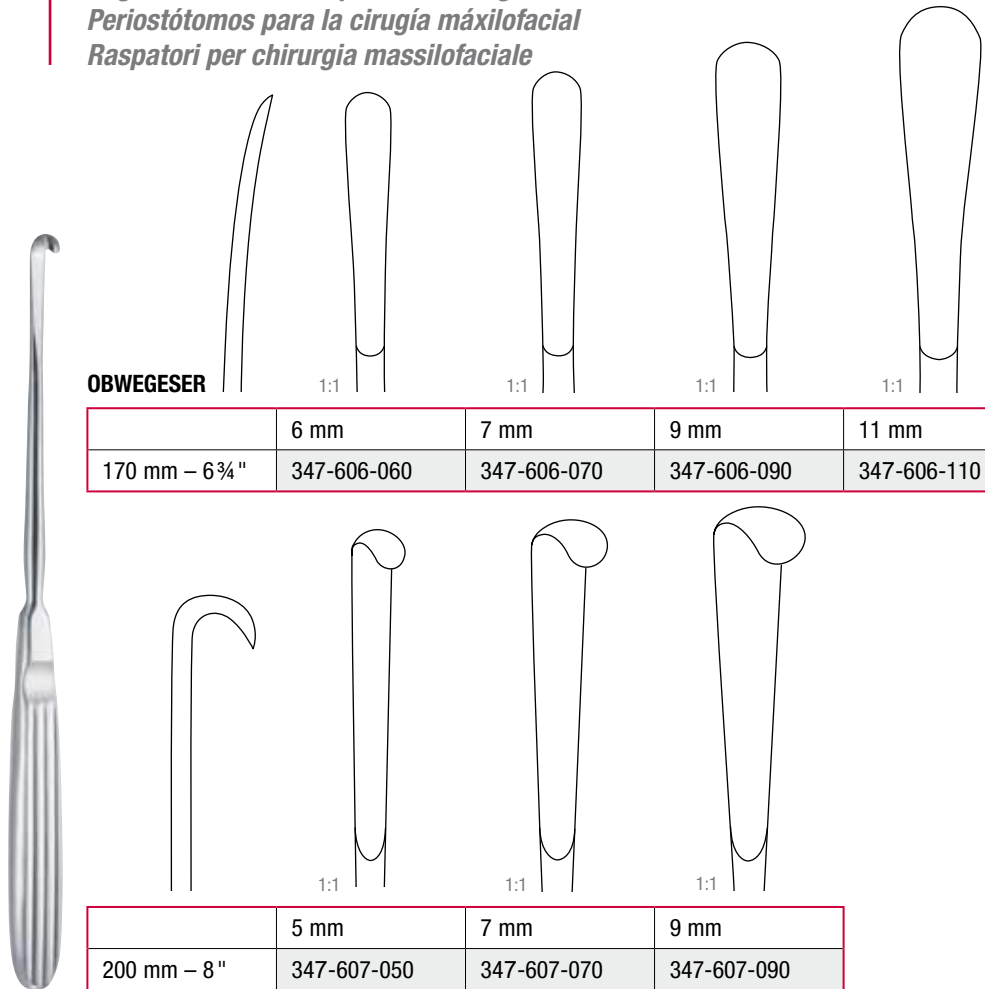
Raspatorien für die Kieferchirurgie
Periosteal elevators for maxillo-facial surgery
Rugines – Décolleurs pour la chirurgie maxillo-faciale
Periostótomos para la cirugía máxilofacial
Raspatori per chirurgia massilofaciale

OBWEGESER

	6 mm	7 mm	9 mm	11 mm
170 mm – 6 ¾"	347-606-060	347-606-070	347-606-090	347-606-110

	5 mm	7 mm	9 mm
200 mm – 8"	347-607-050	347-607-070	347-607-090

OBWEGESER-FREER

210 mm – 8 ¼"	347-610-210
---------------	-------------

OBWEGESER-FREER

210 mm – 8 ¼"	347-612-210
---------------	-------------

Raspatorien und Ahlen für die Kieferchirurgie

Periosteal elevators and awls for maxillo-facial surgery

Rugines, décolleurs et passe-fils pour chirurgie maxillo-faciale

Periostótomos y leznas para la cirugía máxilofacial

Raspatori, punteruoli per chirurgia massilofaciale

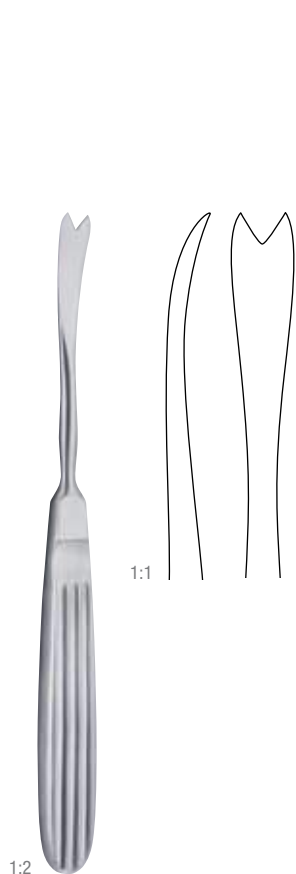

1:2

OBWEGESER

175 mm – 7"	347-608-020
-------------	-------------



1:1

1:2

OBWEGESER

230 mm – 9"	347-675-230
-------------	-------------



1:1

OBWEGESER

180 mm – 7"	21-210-180
-------------	------------

230 mm – 9"	21-210-230
-------------	------------

280 mm – 11"	21-210-280
--------------	------------



1:1

1:2

OBWEGESER

130 mm – 5"	21-220-130
-------------	------------

Raspatorien – Elevatorien
Periosteal raspatories – Elevators
Rugines – Elévateurs
Raspatorios – Elevadores
Periostotomi – Elevatori

DOYEN

170 mm – 6 ¾"	26-755-170	26-751-170
240 mm – 9 ½"	26-755-240	

links
 left
 gauche
 izquierda
 sinistra

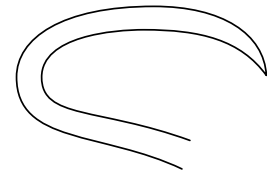
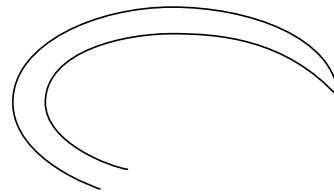

für Erwachsene
 for adults
 pour adultes
 para adultos
 per adulti

für Kinder
 for children
 pour enfants
 para niños
 per bambini



DOYEN

170 mm – 6 ¾"	26-757-170	26-753-170
240 mm – 9 ½"	26-757-240	

rechts
 right
 droite
 derecha
 destra

für Erwachsene
 for adults
 pour adultes
 para adultos
 per adulti

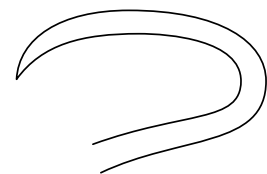
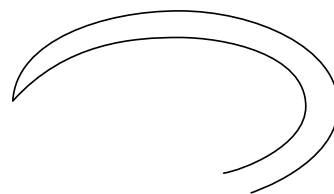
für Kinder
 for children
 pour enfants
 para niños
 per bambini



Raspatorien – Elevatorien
Periosteal raspatories – Elevators
Rugines – Elévateurs
Raspatorios – Elevadores
Periostotomi – Elevatori

QUERVAIN 1:2 1:1 1:1

	x = 6 mm
195 mm – 7¾"	331-746-200

TRELAT 1:2 1:1 1:1

	x = 8 mm
150 mm – 6"	422-445-140

KÖNIG 1:2 1:1 1:1

	x = 4.5 mm	x = 4.5 mm
155 mm – 6"	331-812-150	331-813-150

Raspatorien – Elevatorien
Periosteal raspatories – Elevators

Rugines – Elévateurs
Raspatorios – Elevadores
Periostotomi – Elevatori

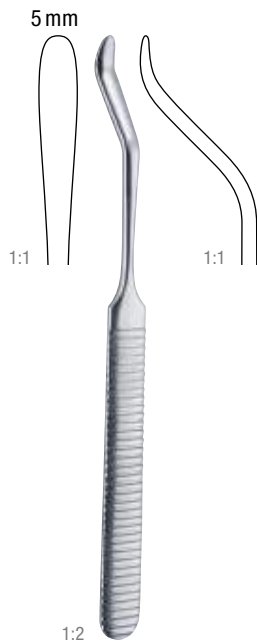

160 mm – 6¼" 422-519-160

ALDERDYCE

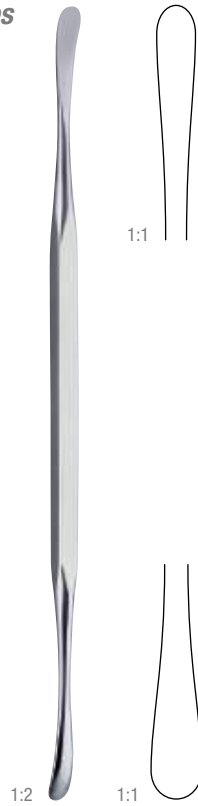

210 mm – 8¼" 422-521-210

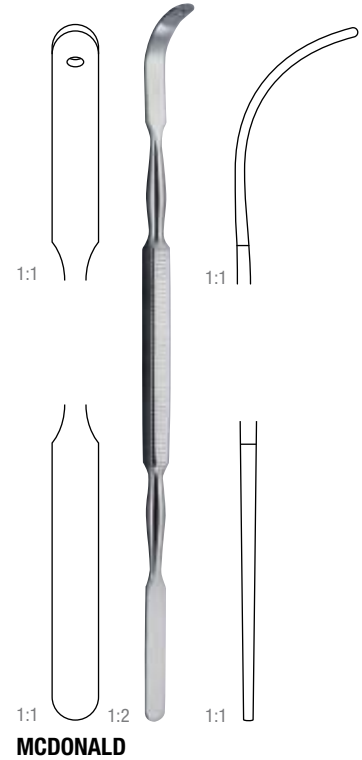

MCDONALD

190 mm – 7½" 331-763-190



SEDILLOT

185 mm – 7¼" 331-704-185
210 mm – 8¼" 331-705-210

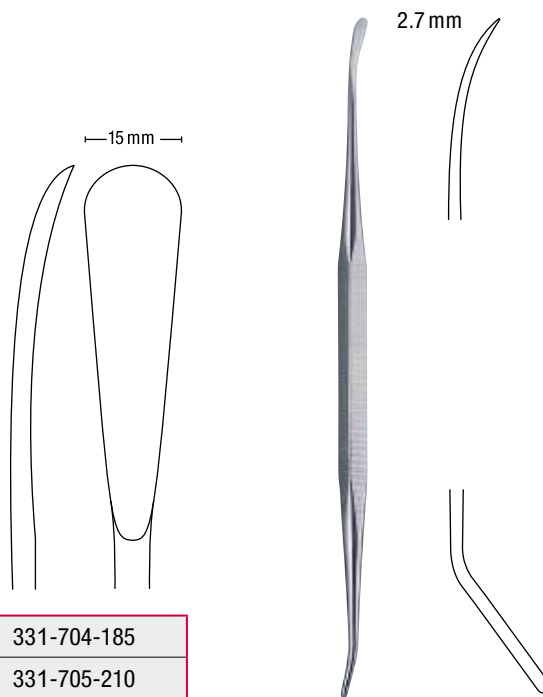

**WATSON-
CHEYNE**

130 mm – 5⅛" 331-762-130
190 mm – 7½" 331-762-190

Raspatorien – Elevatorien

Periosteal raspatories – Elevators

Rugines – Elévateurs
 Raspatorios – Elevadores
 Periostotomi – Elevatori

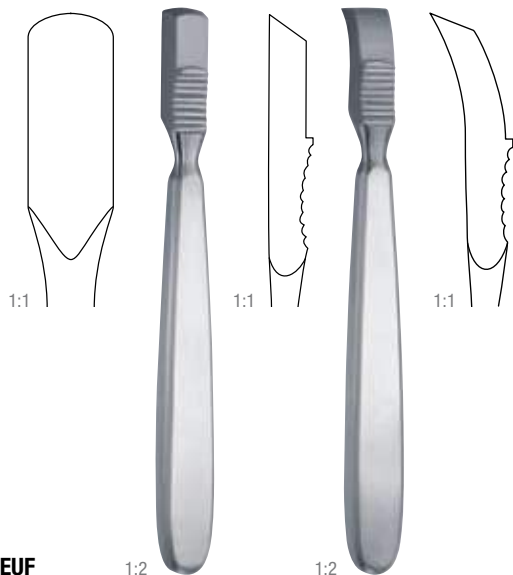

FARABEU

150 mm – 6"	26-720-150	26-721-150
-------------	------------	------------

gerade
 straight
 droit
 recta
 retto

gebogen
 curved
 courbe
 curva
 curvo

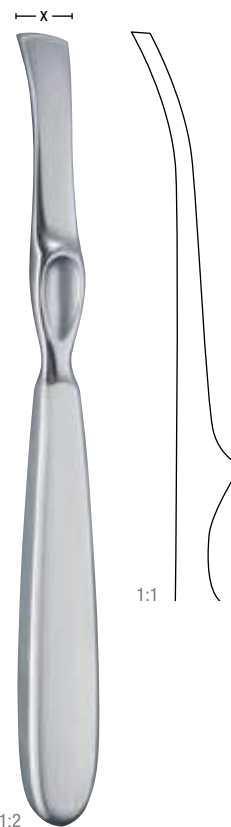

LAMBOTTE

	210 mm – 8 ¼"
x = 5 mm	331-701-050
x = 10 mm	331-701-100
x = 15 mm	331-701-150
x = 20 mm	331-701-200
x = 25 mm	331-701-250



ADSON

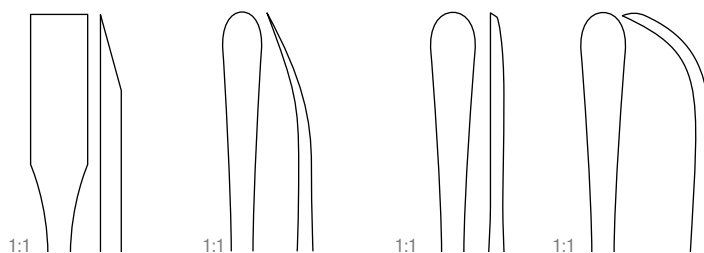
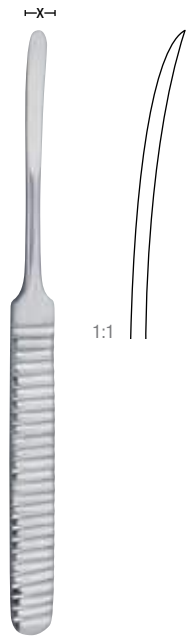
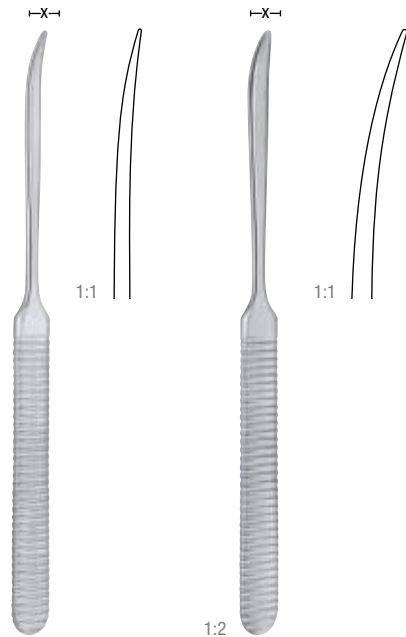

	Fig. 1	Fig. 2	Fig. 3	Fig. 4
170 mm – 6 ¾"	331-750-170	331-751-170	331-752-170	331-753-170

Raspatorien – Elevatorien
Periosteal raspatories – Elevators
Rugines – Elévateurs
Raspatorios – Elevadores
Periostotomi – Elevatori

WILLIGER

1:2

	160 mm – 6 ¼"
x = 4 mm	26-741-160
x = 5 mm	26-742-160

WILLIGER

1:2

1:2

	x = 5 mm	x = 6.5 mm
160 mm – 6 ¼"	26-243-160	26-241-170

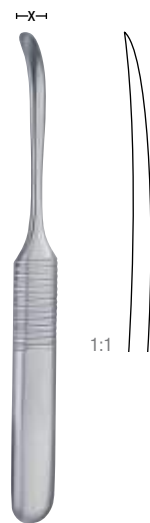
WILLIGER

1:2

	x = 5 mm
130 mm – 5"	381-890-130

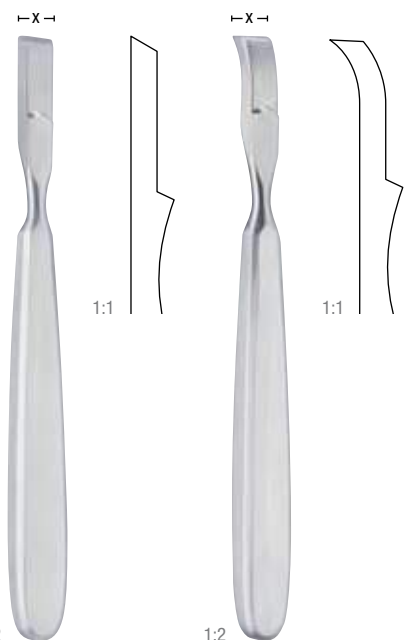

**FARABEUF-
COLLIN**

1:2

1:2

	x = 11 mm	x = 11 mm
160 mm – 6 ¼"	331-698-160	331-699-160

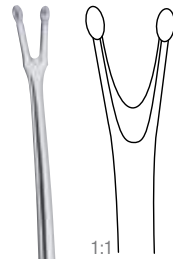
Raspatorien – Elevatorien
Periosteal raspatories – Elevators
Rugines – Elévateurs
Raspatorios – Elevadores
Periostotomi – Elevatori



OBWEGESER 1:2
 185 mm – 7 ¼" 347-626-190

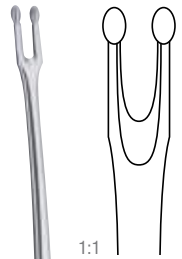

OBWEGESER 1:2
 185 mm – 7 ¼" 347-628-190

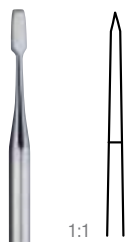

OBWEGESER 1:2



1:1



1:1



1:1

	2.5 mm	4 mm	6.5 mm
150 mm – 6"	347-616-020	347-616-040	347-616-060

Raspatorien – Elevatorien
Periosteal raspatories – Elevators
Rugines – Elévateurs
Raspatorios – Elevadores
Periostotomi – Elevatori



SEMB

1:2

1:2

1:2

1:2

1:2

1:2

175 mm – 7"	210 mm – 8¼"	175 mm – 7"	210 mm – 8¼"	225 mm – 8¾"	220 mm – 8¾"
12 mm	12 mm	13 mm	13 mm	13 mm	15 mm
331-725-010	331-725-020	331-725-030	331-725-040	331-725-050	331-725-090

Raspatorien – Elevatorien
Periosteal raspatories – Elevators
Rugines – Elévateurs
Raspatorios – Elevadores
Periostotomi – Elevatori

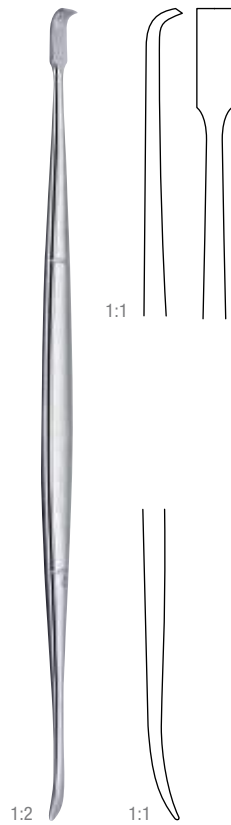

HOWARTH

215 mm – 8½"	436-577-210
--------------	-------------

scharf / stumpf
 sharp / blunt
 pointu / mousse
 aguda / roma
 acuta / smussa

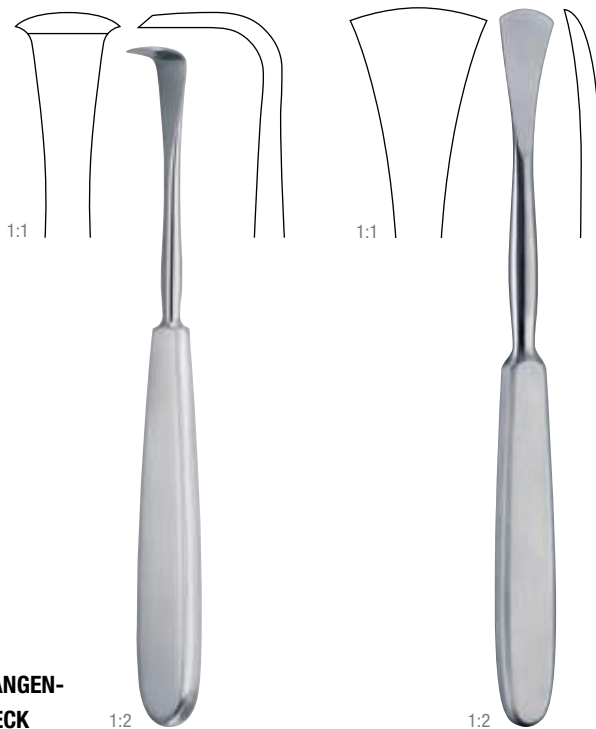

**LANGEN-
BECK**

180 mm – 7"	190 mm – 7½"
331-707-180	26-731-190

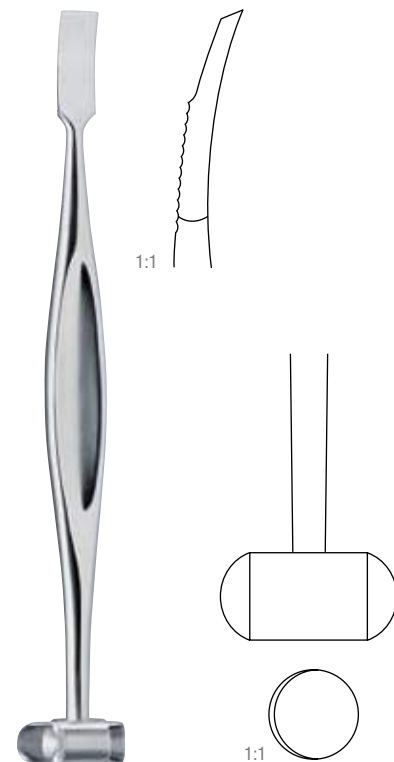

ALEXANDER

160 mm – 6¼"	331-711-160
200 mm – 8"	331-711-200

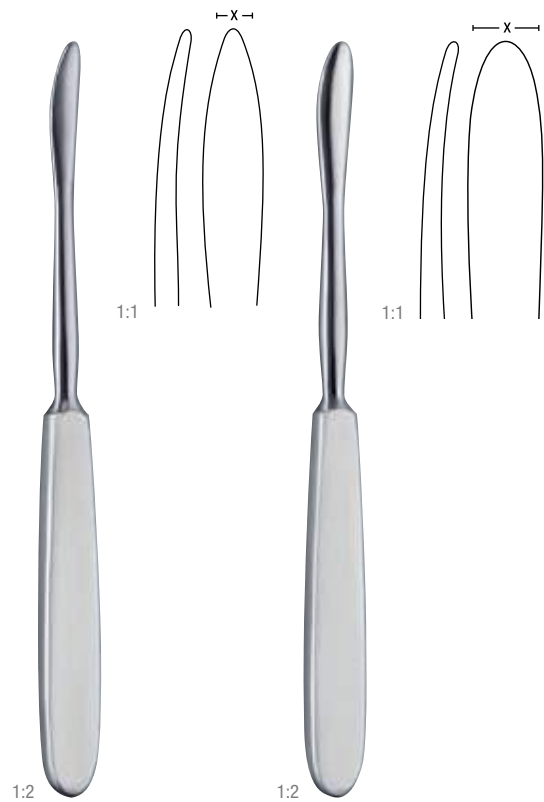
Raspatorien – Elevatorien
Periosteal raspatories – Elevators
Rugines – Elévateurs
Raspatorios – Elevadores
Periostotomi – Elevatori

LANGENBECK

	x = 8 mm	x = 10 mm
200 mm – 8"	26-221-200	26-223-200

SEBILEAU

	x = 5 mm
175 mm – 7"	331-744-170

175 mm – 7"	422-510-170
-------------	-------------

extrem leicht
 extremely light
 extrêmement léger
 extremadamente ligero
 estremamente leggera

Raspatorien – Elevatorien
Periosteal raspatories – Elevators

Rugines – Elévateurs
Raspatorios – Elevadores
Periostotomi – Elevatori



COBB 1:2

	290 mm – 11 ½"
x = 8 mm	331-496-008
x = 10 mm	331-496-010
x = 12 mm	331-496-012
x = 13 mm	331-496-013
x = 19 mm	331-496-019
x = 25 mm	331-496-025

Wirbelsäulen-Raspatorium
 Spinal raspatory
 Rugine vertebraal
 Raspador vertebral
 Periostotomo vertebrale



KEY

180 mm – 7"	190 mm – 7 ½"	190 mm – 7 ½"
x = 6 mm	x = 9 mm	x = 12 mm
331-755-060	331-755-090	331-755-120

200 mm – 8"	210 mm – 8 ¼"
x = 19 mm	x = 25 mm
331-755-190	331-755-250

Raspatorien
Periosteal raspatories
Rugines
Raspatorios
Periostotomi

1:2

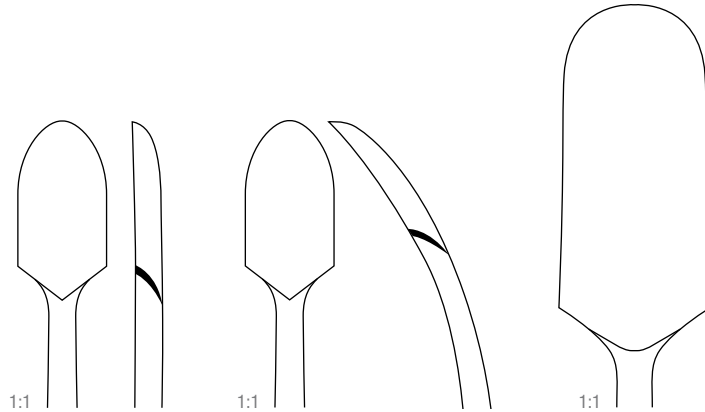

	Fig. 1	Fig. 2	Fig. 3
	14 mm	14 mm	20 mm
200 mm – 8"	331-770-140	331-771-140	422-433-200

Ferrozellgriff
 Ferrozell handle
 Manche en Ferrozell
 Mango en Ferrozell
 Manico di Ferrozell

gerade
 straight
 droit
 recta
 retto

gebogen
 curved
 courbe
 curva
 curvo

gerade
 straight
 droit
 recta
 retto

1:2

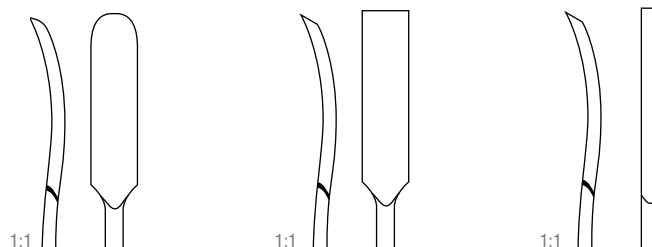

	Fig. 1	Fig. 2	Fig. 3
	6 mm	3 mm	6 mm
180 mm – 7"	331-777-060	331-775-060	331-779-030

Ferrozellgriff
 Ferrozell handle
 Manche en Ferrozell
 Mango en Ferrozell
 Manico di Ferrozell

Knochenchirurgie

Bone surgery

09

Knochenheber Bone levers

Leviers à os
Elevadores para huesos
Elevatori per ossa



HOHMANN

220 mm – 8 ¾"	240 mm – 9 ½"	240 mm – 9 ½"	240 mm – 9 ½"
x = 8 mm	x = 18 mm	x = 43 mm	x = 70 mm
66-825-008	66-825-018	66-825-043	66-825-070

Knochenhebel
Bone levers

Leviers à os
Elevadores para huesos
Elevatori per ossa



HOHMANN

245 mm – 9¾"	260 mm – 10¼"	280 mm – 11"	265 mm – 10½"	260 mm – 10¼"
x = 43 mm	x = 22 mm	x = 33 mm	x = 24 mm	x = 22 mm
66-829-043	66-829-022	66-829-033	331-803-240	331-805-220

Knochenchirurgie

Bone surgery

Knochenheber Bone levers

Leviers à os
Elevadores para huesos
Elevatori per ossa



**MINI-
HOHMANN**

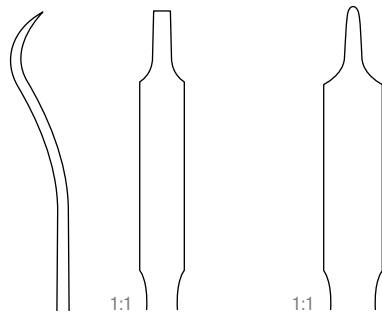

	6 mm	8 mm
160 mm – 6 ¼"	66-821-006	66-821-008



BRISTOW

230 mm – 9"	331-833-230
-------------	-------------

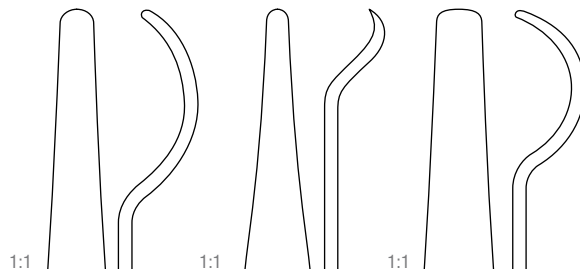

	2.8 mm	4.5 mm	6 mm
140 mm – 5 ½"	331-811-050	331-811-060	331-811-065

LANE

210 mm – 8 ¼"	331-831-270
---------------	-------------

Knochenhebel

Bone levers

Leviers à os

Elevadores para huesos

Elevatori per ossa



BENNETT

1:2

	240 mm – 9½"
x = 43 mm	66-851-240
x = 60 mm	331-767-710

← 30 mm →



MURPHY-LANE

1:2

← 18 mm →

340 mm – 13½"	331-765-300
---------------	-------------

Luxationshebel

Luxation lever

Levier de luxation

Palanca de luxación

Leva per luxazione

Knochenhebel
Bone levers

Leviers à os
Elevadores para huesos
Elevatori per ossa



BLOUNT

1:2

1:2

260 mm – 10¼"	331-819-260	331-821-260
---------------	-------------	-------------



**LANGE-
 HOHMANN MOD.**

265 mm – 10½"	280 mm – 11"
x = 30 mm	x = 33 mm
331-789-300	331-789-340

Knochenhebel

Bone levers

Leviers à os

Elevadores para huesos

Elevatori per ossa

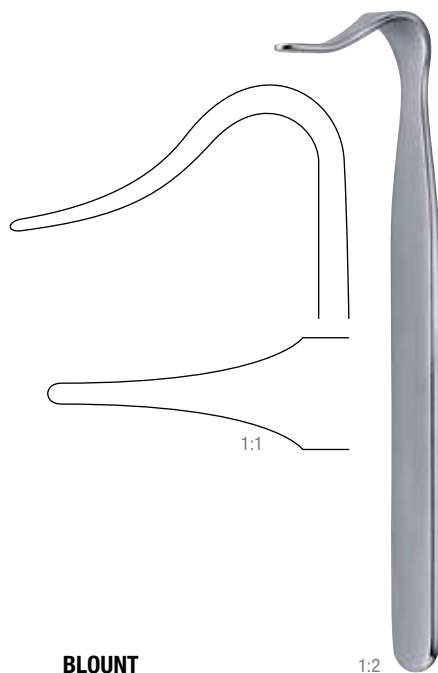

BLOUNT

1:2

175 mm – 7"	331-823-170
-------------	-------------



TAYLOR

	165 mm – 6½"
a = 75 mm – b = 30 mm	331-827-160
a = 100 mm – b = 30 mm	331-829-160

Meniskotome

Meniscotomy knives

Bistouries à ménisques

Bisturías para meniscós

Bisturi per menisco



BIRCHER 1:2

190 mm – 7 ½"

01-821-190

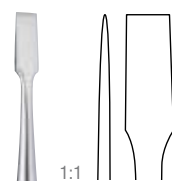

1:1



1:1

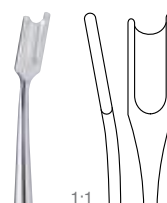

1:1

SMILLIE

1:2



1:2



1:2



170 mm – 6 ¾"

01-870-001

01-870-002

01-870-003

Meniskotome

Meniscotomy knives

Bistouries à ménisques

Bisturías para meniscós

Bisturi per menisco

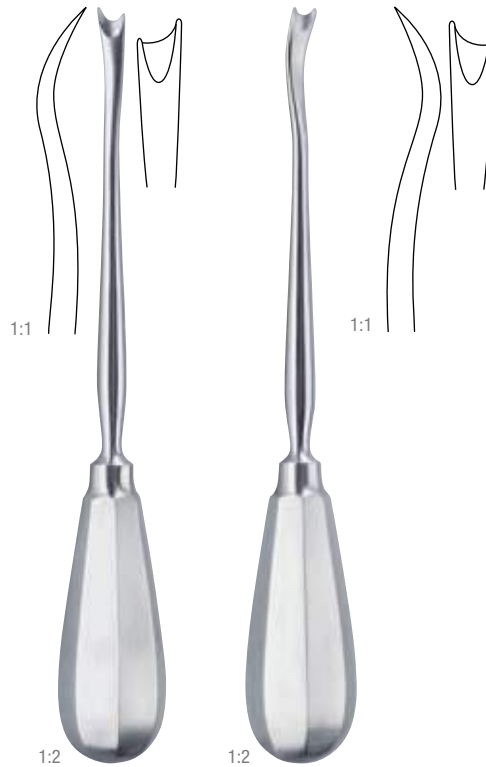

**CANAD.
MODELL**

	Fig. 1	Fig. 2
200 mm – 8"	01-847-200	01-849-200

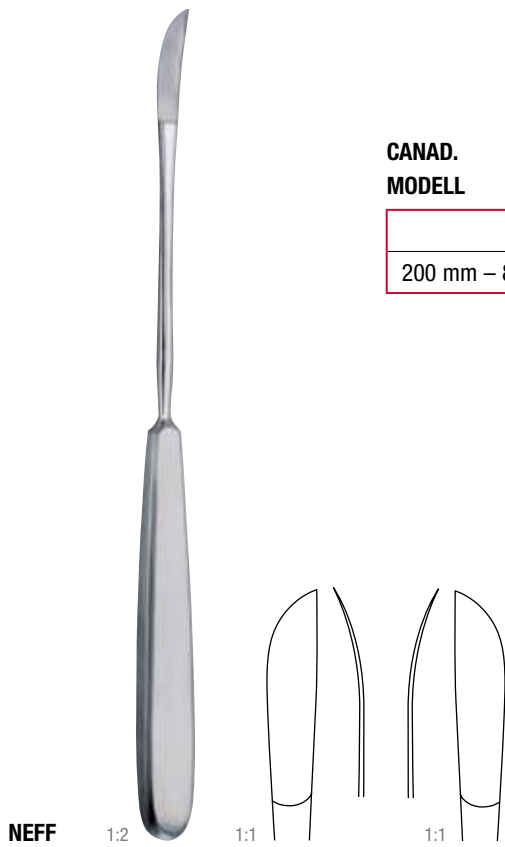

NEFF

220 mm – 8 3/4"

01-831-220

01-833-220

links
Ivra

rechts
right
droite
derecha
destra

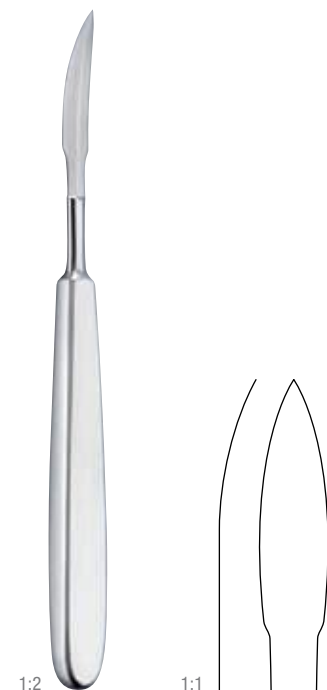

180 mm – 7"



01-837-175

Sehnenstripper
Tendon strippers

Instruments à écorcher les tendons
Enucleadores de tendones
Scollatendini



1:2



	1:1 	1:1 	1:1 
	4.0 mm Ø	4.5 mm Ø	5.5 mm Ø
230 mm – 9"	422-650-400	422-650-450	422-650-550



Schaft biegsam
Malleable shaft
Tige malléable
Flecha maleable
Asta malleabile



1:2

BUNNELL

	1:1 	1:1 	1:1 
	Fig. 1	Fig. 2	Fig. 3
150 mm – 6"	66-920-001	66-920-002	66-920-003

	1:1 	1:1 
Fig. 4	Fig. 5	
66-920-004	66-920-005	

Sehnenstripper

Tendon strippers

Instruments à écorcher les tendons

Enucleadores de tendones

Scollatendini



FISCHER

1:2

310 mm – 12 ¼"	422-656-310
----------------	-------------



BUNNELL

1:2

230 mm – 9"

66-934-230

Sehnedurchzugs-sonde

Tendon passer

Sonde conductrice pour tendons

Sonda conductora de tendones

Sonda conduttrice per tendini



1:2

**KLEINERT-
KUTZ**

200 mm – 8"

20 mm Ø

422-677-200

Sehnenfazzangen

Tendon holding forceps

Pinces pour saisir les tendons

Pinzas para coger tendones

Pinze per afferrare tendini



BRAND

1:1



1:1



1:1



150 mm – 6 "	190 mm – 7 1/2 "	240 mm – 9 1/2 "
66-951-150	66-951-190	66-951-240



1:2

1:1

130 mm – 5 "	422-676-130
--------------	-------------



1:2

1:1

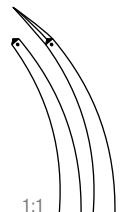

150 mm – 6 "	422-678-150	422-679-150
--------------	-------------	-------------

Hohlmeißelzangen
Bone rongeurs
Pinces gouges
Pinzas gubias
Pinze sgorbie



LUER

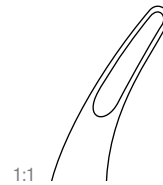
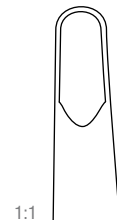

	Fig. 1	Fig. 2
150 mm – 6"	30-375-150	30-377-150



LUER



170 mm – 6 3/4"	30-370-170	30-371-170
-----------------	------------	------------



1:2
MINI-FRIEDMANN

120 mm – 4 3/4"	331-097-120
-----------------	-------------



1:2
FRIEDMANN

140 mm – 5 1/2"	30-321-140
-----------------	------------

Hohlmeißelzangen
Bone rongeurs
Pinces gouges
Pinzas gubias
Pinze sgorbie



1:2

BLUMENTHAL

1:1



1:1

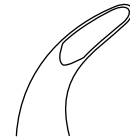

1:1



	Fig. 1	Fig. 2	Fig. 3
155 mm – 6"	30-341-155	30-343-155	30-345-155



1:2

JANSEN

1:1



1:1



	Fig. 1	Fig. 2
180 mm – 7"	422-822-180	422-823-180

Hohlmeißelzangen
Bone rongeurs
Pinces gouges
Pinzas gubias
Pinze sgorbie



ADSON 1:2

200 mm – 8"

331-138-200

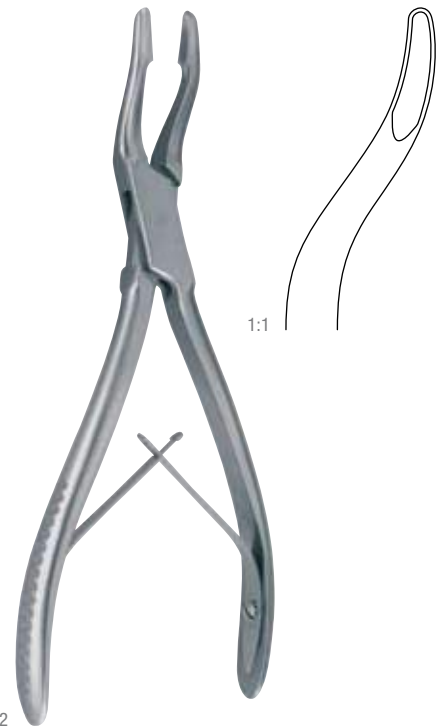

JANSEN 1:2

190 mm – 7½"

331-163-190



1:2
BACON

210 mm – 8¼"

331-161-200

Hohlmeißelzangen
Bone rongeurs
Pinces gouges
Pinzas gubias
Pinze sgorbie



LEMPERT

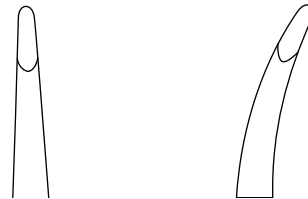

160 mm – 6 ¼"	331-146-160	331-147-160
190 mm – 7 ½"	30-350-190	331-151-180



1:2

STELLBRINK

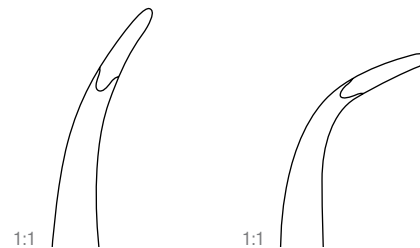

175 mm – 7"	30-331-170	30-333-170
-------------	------------	------------

leicht gebogen
 slightly curved
 légèrement courbe
 ligeramente curvada
 legermente curvata

stark gebogen
 strongly curved
 très courbe
 fuertemente curvada
 fortemente curvata

Hohlmeißelzangen

Bone rongeurs

Pinces gouges

Pinzas gubias

Pinze sgorbie



OLIVECRONA 1:2

205 mm – 8"

331-143-200



HARTMANN 1:2

175 mm – 7"

422-815-180

Hohlmeißelzangen
Bone rongeurs
Pinces gouges
Pinzas gubias
Pinze sgorbie



MEAD

1:2

165 mm – 6½"

30-335-165

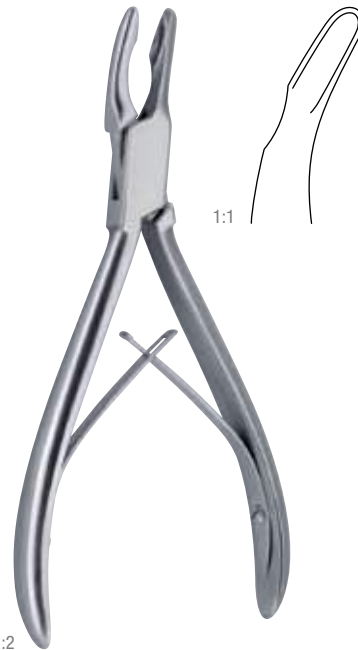

CLEVELAND

1:2

170 mm – 6¾"

30-329-170



CLEVELAND

1:2

140 mm – 5½"

30-329-140

Hohlmeißelzangen
Bone rongeurs
Pinces gouges
Pinzas gubias
Pinze sgorbie



Hohlmeißelzangen
Bone rongeurs
Pinces gouges
Pinzas gubias
Pinze sgorbie



BEYER

180 mm – 7"	30-421-180
-------------	------------



RUSKIN

180 mm – 7"	331-212-180	30-431-180
-------------	-------------	------------



MAYFIELD

175 mm – 7"	422-879-170
-------------	-------------

Hohlmeißelzangen
Bone rongeurs
Pinces gouges
Pinzas gubias
Pinze sgorbie



1:2

**STILLE-
RUSKIN**

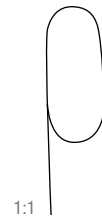

1:1

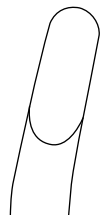

1:1

230 mm – 9"

30-440-230

30-441-230



1:2

STILLE



1:1

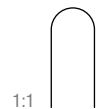

1:1



1:1

	4 mm	6 mm	8 mm
230 mm – 9"	30-443-230	30-445-230	30-447-230

Hohlmeißelzangen
Bone rongeurs
Pinces gouges
Pinzas gubias
Pinze sgorbie

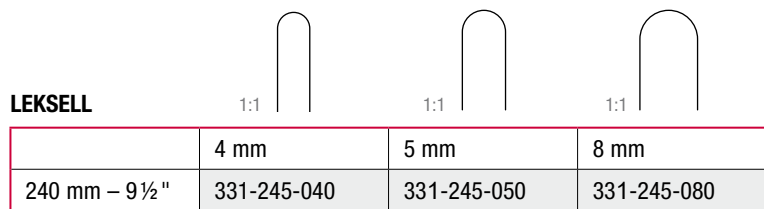

Hohlmeißelzangen
Bone rongeurs
Pinces gouges
Pinzas gubias
Pinze sgorbie



1:2
**RÖTTGEN-
RUSKIN**

230 mm – 9"

30-431-230



1:2
SEMB

225 mm – 9"

331-257-220

Knochenchirurgie

Bone surgery

Hohlmeißelzangen
Bone rongeurs
Pinces gouges
Pinzas gubias
Pinze sgorbie



1:2

ECHLIN

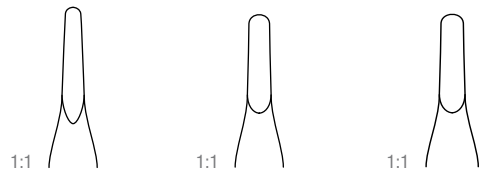

	2 mm	3 mm	4 mm
230 mm – 9"	331-255-020	331-255-030	331-255-040



1:2

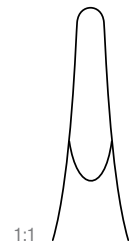

FRYKHOLM

240 mm – 9½"	331-251-240
--------------	-------------

Hohlmeißelzangen
Bone rongeurs
Pinces gouges
Pinzas gubias
Pinze sgorbie



SAUERBRUCH

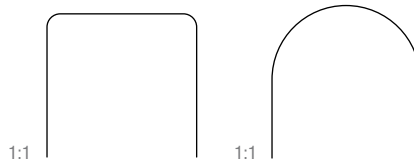
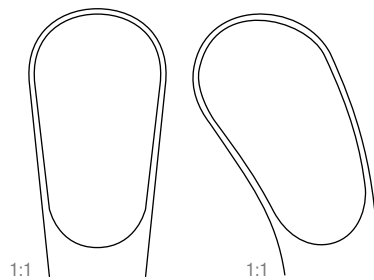

	Fig. 1	Fig. 2
300 mm – 12"	331-237-300	331-239-300



LUER-STILLE



230 mm – 9"	422-908-230	422-909-230
270 mm – 10¾"	422-908-270	422-909-270

Knochensplitterzangen

Bone cutting forceps

Pinces coupantes à os
Pinzas cortantes para huesos
Cesoie per ossa



1:2

**COTTLE-
KAZANJIAN**

190 mm – 7 ½"



1:1

331-278-190



LISTON

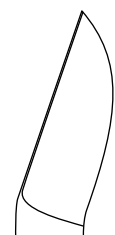

140 mm – 5 ½"	30-720-140	30-721-140
170 mm – 6 ¾"	30-720-170	30-721-170
190 mm – 7 ½"	30-720-190	30-721-190
220 mm – 8 ¾"	30-720-220	30-721-220

Knochensplitterzangen
Bone cutting forceps

Pinces coupantes à os
Pinzas cortantes para huesos
Cesoie per ossa

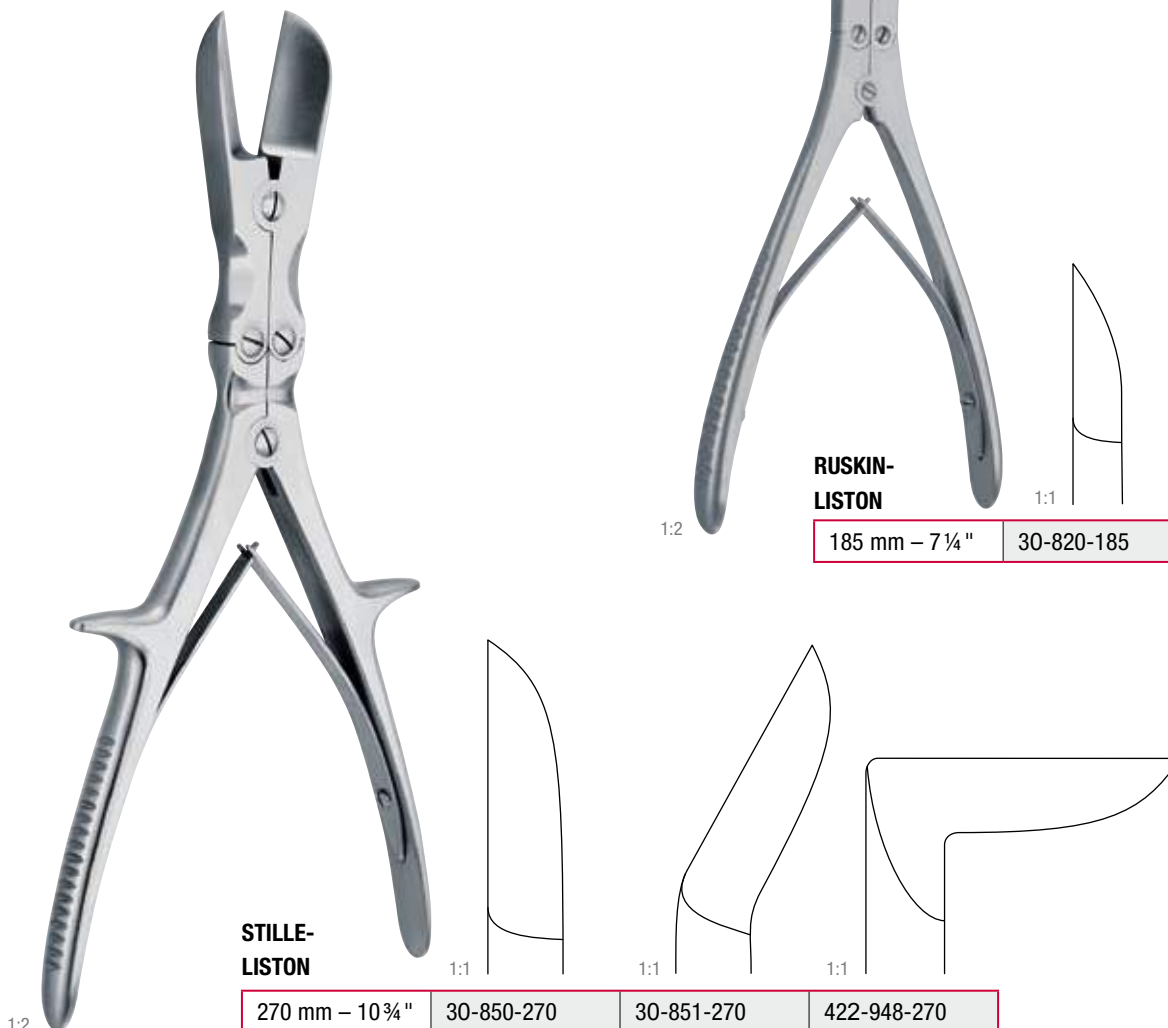
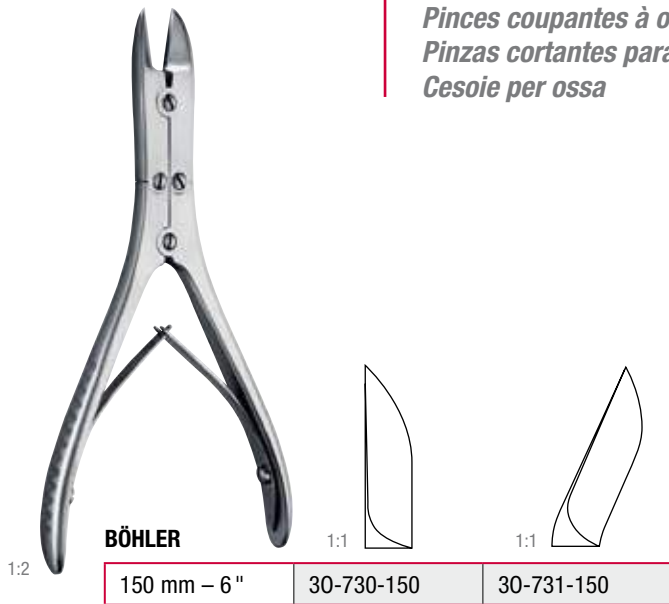

Knochenchirurgie

Bone surgery

09

Knochensplitterzangen

Bone cutting forceps

Pinces coupantes à os
Pinzas cortantes para huesos
Cesoie per ossa



1:2
SEM

240 mm – 9½"	331-291-240
--------------	-------------



1:2
LISTON-KEY HORSLEY

270 mm – 10¾"	30-853-270
---------------	------------

Knochenhalteklammern – Knochenhaltezangen
Bone holding clamps – Bone holding forceps
Daviers à os – Daviers porte-os
Pinzas porta huesos – Pinzas para huesos
Tenaglie per ossa

GERSTER-LOWMANN

130 mm – 5 "	x = 22 mm	30-224-130
180 mm – 7 "	x = 28 mm	30-224-180
200 mm – 8 "	x = 35 mm	30-224-200
220 mm – 8 ¾ "	x = 40 mm	30-224-220

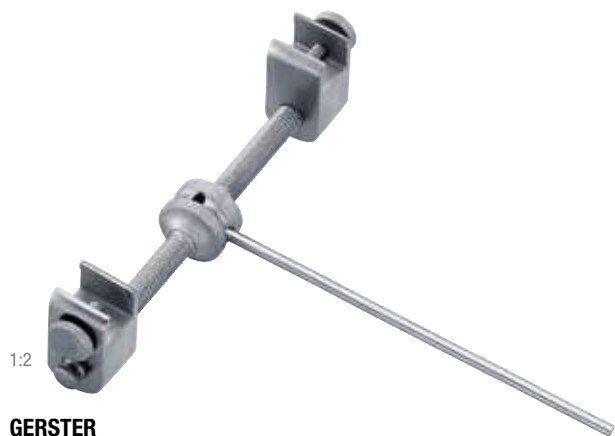
GERSTER

150 mm – 6 "	30-230-150
--------------	------------

Knochenchirurgie

Bone surgery

Knochenhaltezangen – Repositionszangen
Bone holding forceps – Reposition forceps

Daviers porte-os – Pincas de reposition
Pinzas para huesos – Pinzas para reposición
Tenaglie per ossa – Pinze per riposizioni



135 mm – 5 ¼" 422-710-140



LEWIN 175 mm – 7" 30-114-175

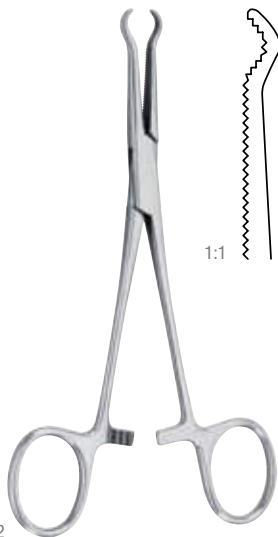

140 mm – 5 ½" 422-716-140

Knochenhalteklammern – Knochenhaltezangen
Bone holding clamps – Bone holding forceps

Daviers à os – Daviers porte-os
Pinzas porta huesos – Pinzas para huesos
Tenaglie per ossa



FERGUSSON

1:2

210 mm – 8 ¼"

30-120-210

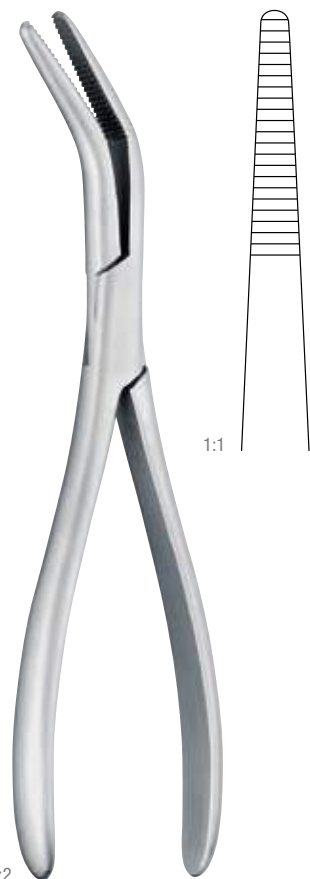

VAN BUREN

1:2

230 mm – 9"

30-081-230

Knochenchirurgie

Bone surgery

09

Knochenhaltezaugen

Bone holding forceps

Daviers porte-os
Pinzas para huesos
Tenaglie per ossa



LANGENBECK

1:2

210 mm – 8¼"

331-358-210

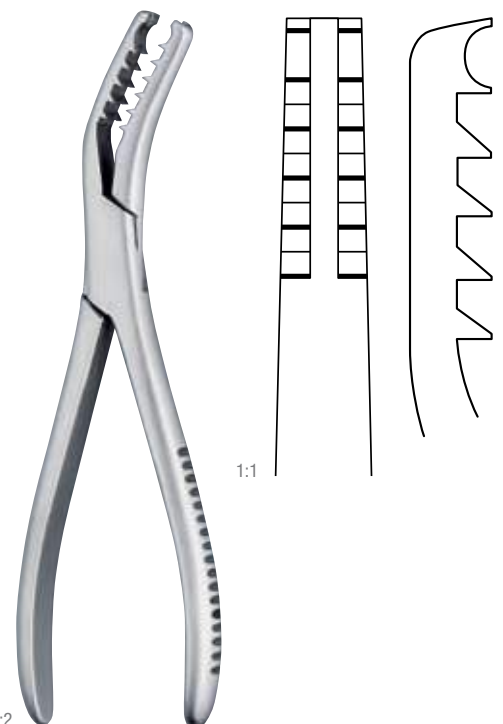

SEMB

1:2

190 mm – 7½"

331-361-190

Knochenhaltezangen
Bone holding forceps

Daviers porte-os
Pinzas para huesos
Tenaglie per ossa

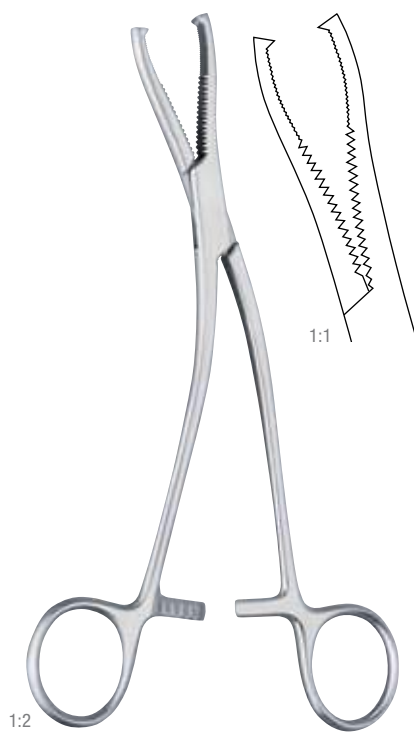

1:2

DINGMANN

190 mm – 7 ½"

30-069-190



1:2

1:1

1:1

200 mm – 8"

331-416-200

331-417-200

Sequesterzange

Sequestrum forceps
Pince pour Sequestrum
Pinza para Sequestrum
Pinza per Sequestrum

Knochenhaltezaugen
Bone holding forceps

Daviers porte-os
Pinzas para huesos
Tenaglie per ossa



FARABEUF

230 mm – 9"	331-362-230
260 mm – 10¼"	331-362-260



FARABEUF-LAMBOTTE

260 mm – 10¼"	331-364-260
---------------	-------------

Knochenhaltezangen
Bone holding forceps

Daviers porte-os
Pinzas para huesos
Tenaglie per ossa



MARTIN

160 mm – 6 ½ "	331-406-160
190 mm – 7 ½ "	331-406-190

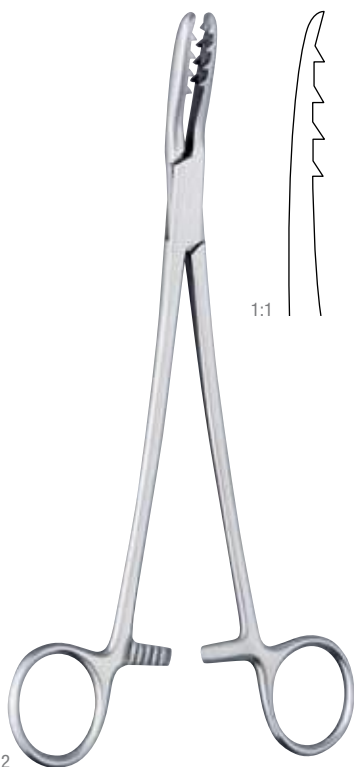

1:1

1:2

**BIRCHER-
GANSKE**



1:1

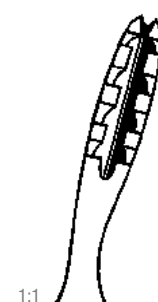

1:1

200 mm – 8 "	30-060-200	30-061-200
--------------	------------	------------

Knochenhaltezangen
Bone holding forceps

Daviers porte-os
Pinzas para huesos
Tenaglie per ossa



HEY GROVES

210 mm – 8¼"	x = 6.5 mm	331-363-210
270 mm – 10¾"	x = 7.5 mm	331-363-270
305 mm – 12"	x = 8.5 mm	331-363-305

Knochenhaltezangen
Bone holding forceps

Daviers porte-os
Pinzas para huesos
Tenaglie per ossa

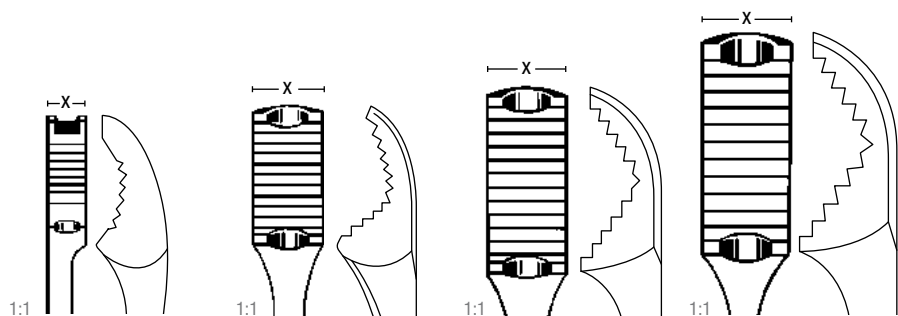

VERBRUGGE

175 mm – 7"	250 mm – 10"	260 mm – 10 ¼"	270 mm – 10 ¾"
x = 5.0 mm	x = 9.5 mm	x = 10.5 mm	x = 12.0 mm
30-171-175	30-171-250	30-171-260	30-171-270

Knochenchirurgie

Bone surgery

09

Knochenhaltezangen

Bone holding forceps

Daviers porte-os
Pinzas para huesos
Tenaglie per ossa



KERN

170 mm – 6¾"	30-130-170	30-132-170
210 mm – 8¼"	30-130-210	30-132-210

Knochenhaltezaugen
Bone holding forceps

Daviers porte-os
Pinzas para huesos
Tenaglie per ossa



LANE

330 mm – 13"	30-160-330	30-162-330
450 mm – 17 ¾"	30-160-450	30-162-450

Knochenchirurgie

Bone surgery

09

Knochenhaltezangen

Bone holding forceps

Daviers porte-os
Pinzas para huesos
Tenaglie per ossa

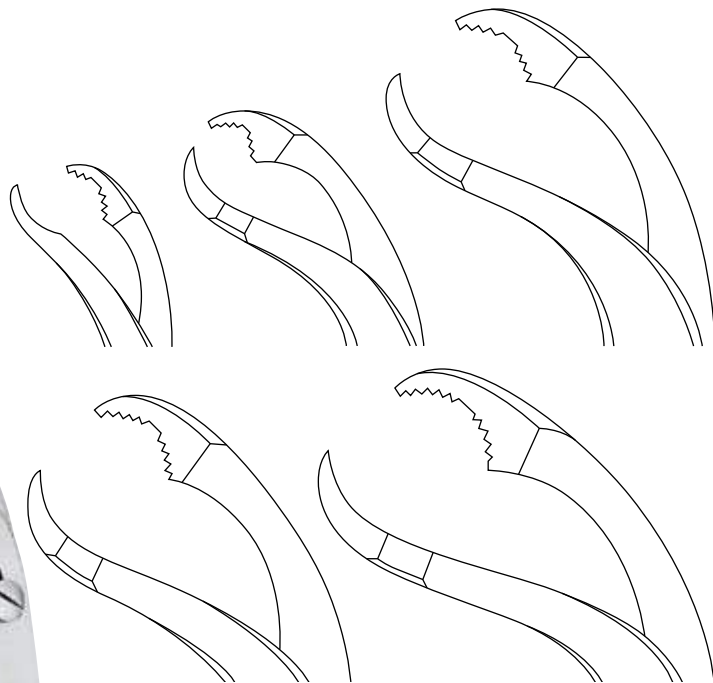
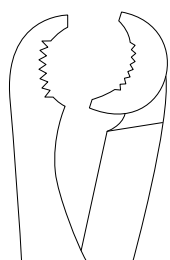

LAMBOTTE

220 mm – 8 ¾ "	331-366-220
270 mm – 10 ¾ "	331-366-270
300 mm – 12 "	331-366-300

ein Maulteil beweglich
 one jaw mobile
 un mors mobile
 una boca movable
 una parte del morso mobile

150 mm – 6 "	x = 2.5 mm	331-387-150
190 mm – 7 ½ "	x = 6.5 mm	331-387-190
240 mm – 9 ½ "	x = 9.5 mm	331-387-240
260 mm – 10 ¼ "	x = 10.0 mm	331-387-260
280 mm – 11 "	x = 11.0 mm	331-387-280

selbstzentrierend
 self-centering
 auto-centreur
 autocentrante
 autocentrante

Knochenhaltezaugen
Bone holding forceps

Daviers porte-os
Pinzas para huesos
Tenaglie per ossa



ULRICH

230 mm – 9"	422-742-230	422-743-230
250 mm – 9¾"	422-742-250	422-743-250
280 mm – 11"	422-742-280	422-743-280



160 mm – 6¼"	422-715-160
240 mm – 9½"	422-715-240

kniegebogen
angular
coudée
acodada
angolata

Knochenhaltezangen – Repositionszangen
Bone holding forceps – Reposition forceps

Daviers porte-os – Pincas de reposition
Pinzas para huesos – Pinzas para reposición
Tenaglie per ossa – Pinze per riposizione



Repositionszangen
Reposition forceps

Pinces de reposition
Pinzas para reposición
Pinze per riposizione

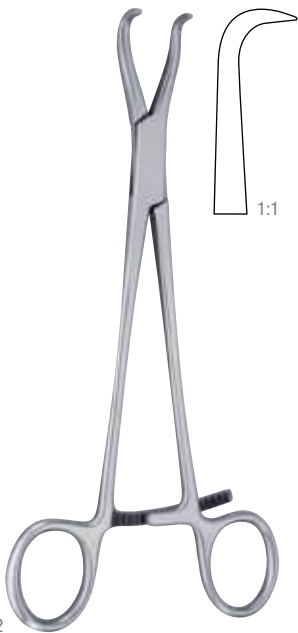

HAASE

165 mm – 6½"	30-055-165
--------------	------------

für Unterkieferfrakturen
for mandibular fractures
pour fractures mandibulaires
para fracturas del mandibulo
per fratture mandibulare



1:2

95 mm – 3¾"	30-057-095
-------------	------------

1:2



1:1

185 mm – 7¼"	331-428-180
--------------	-------------

Patellazange
Patella forceps
Pince pour la rotule
Pinza para la rótula
Pinza per rotula

1:2



1:1

210 mm – 8¼"

331-432-210

Knöchelfasszange
Malleolar forceps
Pince pour la malléole
Pinza para el maleólo
Pinza per malleolo

1:2

Draht-Instrumentarium
Wire instruments

Instruments pour cerclage
Instrumental para cerclaje
Strumenti per filo di cerchiaggio



DEMEL

1:2

	280 mm – 11 "
x = 32 mm	421-531-010
x = 45 mm	421-531-020
x = 62 mm	421-531-030



DEMEL

1:2

280 mm – 11 "	421-534-280
---------------	-------------

Draht-Instrumentarium
Wire instruments
Instruments pour cerclage
Instrumental para cerclaje
Strumenti per filo di cerchiaggio

LOUTE

1:2

210 mm – 8¼"

332-527-210



0.2 mm Ø	332-526-020
0.3 mm Ø	332-526-030
0.4 mm Ø	332-526-040
0.5 mm Ø	332-526-050
0.6 mm Ø	332-526-060
0.7 mm Ø	332-526-070
0.8 mm Ø	332-526-080
0.9 mm Ø	332-526-090
1.0 mm Ø	332-526-100
1.2 mm Ø	332-526-120
1.5 mm Ø	332-526-150



1:2

130 mm – 5"

421-537-000

Knochendraht, weich, in Ringen à 10 m

Bone wire, soft, in coils of 10 m

Fil de cerclage, souple, de 10 m

Alambre de cerclaje, blando, de 10 m

Filo per ossa, morbida, anelli da 10 m

Drahtschneidezangen

Wire cutting forceps

Pinces coupantes

Alicates para cortar alambre

Pinze taglia filo



1:2

185 cm – 7 ¼"	332-546-180
---------------	-------------

Kopfschneider, durchbohrt für harte Drähte bis 1.6 mm Ø

Wire cutting forceps for hard wires up to 1.6 mm Ø

Pince coupante pour fils durs à 1.6 mm Ø

Alicate para alambres duros hasta 1.6 mm Ø

Pinza taglia fili per fili duri fino a 1.6 mm Ø

	almedur
470 mm – 18 ½"	332-552-470
570 mm – 22 ½"	332-552-560

für Kirschner Drähte und Steinmann Nägel bis 6 mm Ø
 for Kirschner wires and Steinmann pins up to 6 mm Ø
 pour des broches Kirschner et clous Steinmann à 6 mm Ø
 para agujas de Kirschner y clavos de Steinmann hasta 6 mm Ø
 per fili Kirschner e chiodi Steinmann fino a 6 mm Ø

almedur
332-552-470/1

Hartmetallplättchen alleine
 tungsten carbide inlay only
 plaquettes de carbure de tungstène
 inserto de carburo de tungsteno
 inserti carburo di tungsteno

Drahtschneidezangen
Wire cutting forceps
Pinces coupantes
Alicates para cortar alambre
Pinze taglia filo

	almedur
220 mm – 8 3/4"	332-537-220

für harte Drähte bis 2.2 mm Ø, für weiche Drähte bis 3 mm Ø
 for hard wires up to 2.2 mm Ø, for soft wires up to 3 mm Ø
 pour fils durs à diam. 2.2 mm Ø, pour fils souples à 3 mm Ø
 para alambres duros hasta 2.2 mm Ø, y alambres blandos de 3 mm Ø
 per fili duri fina 2.2 mm Ø, per fili morbidi fino a 3 mm Ø

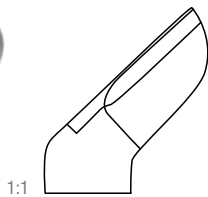

1:2

1:2

	almedur
220 mm – 8 3/4"	66-457-220

für harte Drähte bis 2.2 mm Ø, für weiche Drähte bis 2.8 mm Ø
 for hard wires up to 2.2 mm Ø, for soft wires up to 2.8 mm Ø
 pour fils durs à 2.2 mm Ø, pour fils souples à 2.8 mm Ø
 para alambres duros hasta 2.2 mm Ø, y alambres blandos de 2.8 mm Ø
 per fili duri fina 2.2 mm Ø, per fili morbidi fino a 2.8 mm Ø



1:2

	almedur
230 mm – 9"	332-544-230

für harte Drähte bis 2.2 mm Ø, für weiche Drähte bis 3 mm Ø
 for hard wires up to 2.2 mm Ø, for soft wires up to 3 mm Ø
 pour fils durs à 2.2 mm Ø, pour fils souples à 3 mm Ø
 para alambres duros hasta 2.2 mm Ø, y alambres blandos de 3 mm Ø
 per fili duri fina 2.2 mm Ø, per fili morbidi fino a 3 mm Ø

Knochenchirurgie

Bone surgery

Drahtschneidezangen
Wire cutting forceps
Pincès coupantes
Alicates para cortar alambre
Pinze taglia filo



REILL 1:2

	almedur
180 mm – 7"	332-543-170

für harte Drähte bis 1.5 mm Ø, für weiche Drähte bis 2 mm Ø
 for hard wires up to 1.5 mm Ø, for soft wires up to 2 mm Ø
 pour fils durs à 1.5 mm Ø, pour fils souples à 2 mm Ø
 para alambres duros hasta 1.5 mm Ø, y alambres blandos de 2 mm Ø
 per fili duri fina 1.5 mm Ø, per fili morbidi fino a 2 mm Ø



1:2

	almedur
180 mm – 7"	332-542-180

für harte Drähte bis 1.7 mm Ø, für weiche Drähte bis 2 mm Ø
 for hard wires up to 1.7 mm Ø, for soft wires up to 2 mm Ø
 pour fils durs à 1.7 mm Ø, pour fils souples à 2 mm Ø
 para alambres duros hasta 1.7 mm Ø, y alambres blandos de 2 mm Ø
 per fili fina 1.7 mm Ø, per fili morbidi fino a 2 mm Ø



1:2

	almedur
150 mm – 6"	332-556-150

für harte Drähte bis 1 mm Ø, für weiche Drähte bis 1.5 mm Ø
 for hard wires up to 1 mm Ø, for soft wires up to 1.5 mm Ø
 pour fils durs à 1 mm Ø, pour fils souples à 1.5 mm Ø
 para alambres duros hasta 1 mm Ø, y alambres blandos de 1.5 mm Ø
 per fili duri fina 1 mm Ø, per fili morbidi fino a 1.5 mm Ø



1:2

	almedur
145 mm – 5¾"	332-540-140

für harte Drähte bis 1 mm Ø
 for hard wires up to 1 mm Ø
 pour fils durs à 1 mm Ø
 para alambres duros hasta 1 mm Ø
 per fili duri fino a 1 mm Ø

Drahtschneidezangen

Wire cutting forceps

Pinces coupantes

Alicates para cortar alambre

Pinze taglia filo



1:2

	almedur
260 mm – 10 ¼ "	332-558-260

für harte Drähte bis 3 mm Ø
for hard wires up to 3 mm Ø
pour fils durs à 3 mm Ø
para alambres duros hasta 3 mm Ø
per fili duri fino a 3 mm Ø

Technische Zangen
Technical forceps
Pinces techniques
Pinzas técnicas
Pinze tecniche



130 mm – 5"	332-531-130
180 mm – 7"	332-531-180



130 mm – 5"	66-440-130
170 mm – 6¾"	66-440-170

Technische Zangen
Technical forceps
Pinces techniques
Pinzas técnicas
Pinze tecniche



1:2

170 mm – 6 ¾"

332-562-170



1:2

190 mm – 7 ½"

332-566-190

Technische Zange, verstellbar
Technical forceps, adjustable
Pince technique, ajustable
Pinza técnica, ajustable
Pinza tecnica, regolabile

Technische Zangen

Technical forceps

Pinces techniques

Pinzas técnicas

Pinze tecniche



1:2

1:1

185 mm – 7 ¼"

332-528-170

Drahtbiegezange

Wire bending forceps

Pince à couder

Pinza para torcer

Pinza per piegare



1:2

185 mm – 7 ¼"

332-534-180

Flachzange mit Seitenschneider, parallelfassend, für harte Drähte bis 1.6 mm Ø

Flat nose plier, parallel grip, incorporated cutter, for hard wires up to 1.6 mm Ø

Pince à couder avec coupe latéral, pour des fils durs à de 1.6 mm Ø

Pinza para torcer con corte lateral, para alambres hasta 1.6 mm Ø

Pinza, morso piatto parallelo e taglia fili laterale fino a 1.6 mm Ø

Pinza, morso piatto parallelo e taglia fili laterale fino a 1.6 mm Ø

Pinza, morso piatto parallelo e taglia fili laterale fino a 1.6 mm Ø

Pinza, morso piatto parallelo e taglia fili laterale fino a 1.6 mm Ø

Pinza, morso piatto parallelo e taglia fili laterale fino a 1.6 mm Ø

Pinza, morso piatto parallelo e taglia fili laterale fino a 1.6 mm Ø

Pinza, morso piatto parallelo e taglia fili laterale fino a 1.6 mm Ø

Pinza, morso piatto parallelo e taglia fili laterale fino a 1.6 mm Ø

Pinza, morso piatto parallelo e taglia fili laterale fino a 1.6 mm Ø

Pinza, morso piatto parallelo e taglia fili laterale fino a 1.6 mm Ø

Pinza, morso piatto parallelo e taglia fili laterale fino a 1.6 mm Ø

Pinza, morso piatto parallelo e taglia fili laterale fino a 1.6 mm Ø

Pinza, morso piatto parallelo e taglia fili laterale fino a 1.6 mm Ø

Pinza, morso piatto parallelo e taglia fili laterale fino a 1.6 mm Ø

Pinza, morso piatto parallelo e taglia fili laterale fino a 1.6 mm Ø

Pinza, morso piatto parallelo e taglia fili laterale fino a 1.6 mm Ø

Pinza, morso piatto parallelo e taglia fili laterale fino a 1.6 mm Ø

Pinza, morso piatto parallelo e taglia fili laterale fino a 1.6 mm Ø

Pinza, morso piatto parallelo e taglia fili laterale fino a 1.6 mm Ø



180 mm – 7"

332-529-180

200 mm – 8"

332-529-200

240 mm – 9 ½"

332-529-240

Feststellzange

Locking plier

Pince à caler

Pinza de fijar

Pinza bloccante

Technische Zangen
Technical forceps
Pinces techniques
Pinzas técnicas
Pinze tecniche



220 mm – 8 ¾ "	66-447-220
250 mm – 9 ¾ "	66-447-250
300 mm – 12 "	66-447-300

Feststellzange, allein
 Locking plier, only
 Pince à caler, seul
 Pinza de fijar, sola,
 Pinza bloccante, sola

300 mm – 12 "	66-448-300
---------------	------------

Feststellzange mit Aufnahmestift
 Locking plier with holding pins
 Pince à caler avec groupilles
 Pinza de fijar con perno
 Pinza bloccante con perni per estrattore

460 mm – 18 "	66-449-460
---------------	------------

Feststellzange mit Ausschlagvorrichtung
 Locking plier with extraction device
 Pince à caler avec devis d'extraction
 Pinza de fijar con dispositivo de extracción
 Pinza bloccante con estrattore

Technische Zangen
Technical forceps
Pinces techniques
Pinzas técnicas
Pinze tecniche



200 mm – 8 "	66-454-001
--------------	------------

Plattenbiegezange für Knochenplatten bis 2.7 mm Stärke
Plate bending plier for plates up to 2.7 mm
Pince à couder pour des plaques de 2.7 mm
Pinza para torcer, placas hasta 2.7 mm
Pinza piega placche fino a 2.7 mm

240 mm – 9½ "	66-454-002
---------------	------------

Plattenbiegezange für Knochenplatten bis 4 mm Stärke
Plate bending plier for plates up to 4 mm
Pince à conder pour des plaques de 4 mm
Pinza para torcer, para placas hasta 4 mm
Pinza piega placche fino a 4 mm

Technische Zangen
Technical forceps
Pinces techniques
Pinzas técnicas
Pinze tecniche



1:2

		almedur
	180 mm – 7"	180 mm – 7"
x = 3 mm		421-507-010
x = 5 mm	421-508-180	421-507-020
x = 7 mm	421-510-180	421-507-030



1:2

		almedur
	220 mm – 8 3/4"	421-514-220

Grip-Zange, kombiniert mit TC-Schneider
Grip forceps, combined with TC-Cutter
Pince grip, avec partie coupante TC
Pinza grip, combinada con TC
Pinza grip, con morso tagliente a TC

Extensionsbügel
Extension bows

Etriers pour extension
Estribos para extensión
Archi per estensione



1:3

180 mm – 7"	332-511-020
-------------	-------------

Spannschlüssel für Kirschner Drähte
 Wire strainer for Kirschner wires
 Tendeur pour fils de Kirschner
 Tensor para agujas de Kirschner
 Chiave per estensione di fili Kirschner

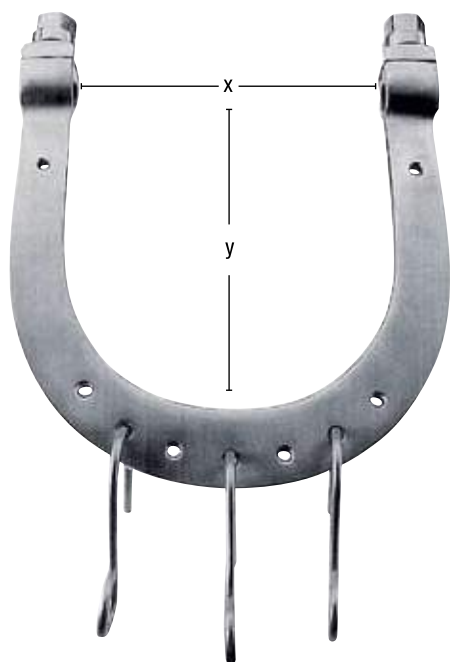

66-360-002

Fixierscheiben für Bohrdrähte alleine (Paar)
 Fixation discs only (pair)
 Disques de fixation seul (paire)
 Disos de fijación sólo (par)
 Disco di fissare solo (paio)

66-367-001

Zughaken klein, alleine
 Traction hooks, only
 Crochets de traction, seul
 Ganchos de tracción, sólo
 Ganci di trazione, solo



KIRSCHNER

x = 130 mm	66-332-160
x = 185 mm	66-332-200
x = 220 mm	66-332-220

mit 3 Zughaken
 with 3 traction hooks
 avec 3 crochets d'attelage
 con 3 ganchos de tracción
 con 3 ganci di trazione

KIRSCHNER

x = 95 mm y = 70 mm	66-326-095
x = 100 mm y = 100 mm	66-326-105
x = 120 mm y = 120 mm	66-326-120
x = 155 mm y = 155 mm	66-326-155
x = 200 mm y = 155 mm	66-326-200

mit 3 Zughaken
 with 3 traction hooks
 avec 3 crochets d'attelage
 con 3 ganchos de tracción
 con 3 ganci di trazione

66-367-002

Zughaken groß alleine
 Traction hooks big, only
 Crochets de traction grand, seul
 Ganchos de tracción grande, sólo
 Ganci di trazione grande, solo

Extensionsbügel
Extension bows
Etriers pour extension
Estribos para extensión
Archi per estensione

KIRSCHNER

x = 180 mm y = 100 mm	66-320-140
x = 270 mm y = 160 mm	66-320-220

mit 3 Zughaken

with 3 traction hooks
 avec 3 crochets d'attelage
 con 3 ganchos de tracción
 con 3 ganci di trazione

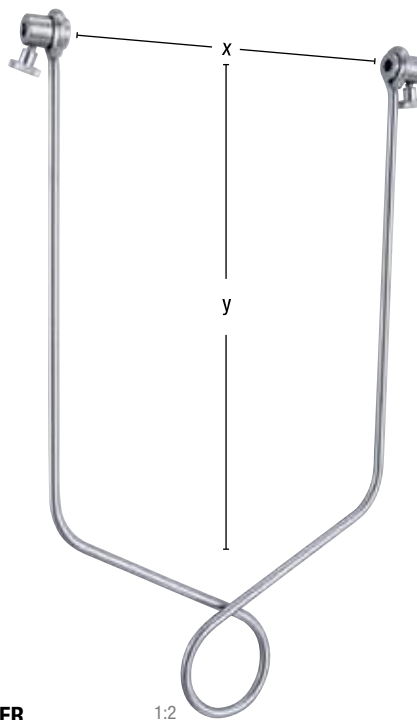
BÖHLER

x = 75 mm y = 90 mm	332-498-090
x = 90 mm y = 160 mm	332-498-160
x = 110 mm y = 210 mm	332-498-210
x = 150 mm y = 210 mm	332-498-211



1:2

	14 mm/17 mm
190 mm – 7½"	66-386-190

Gabelschlüssel

Wrench
 Clé de serrage
 Llave de tuercas
 Chiave per madreviti

Amputationsretraktor – Komprimeter

Amputation retractor – Comprimeter

Rétracteur pour amputation – Comprimètre

Retractor para amputación – Comprimetro

Retrattore per amputazione – Comprimetro



PERCY

1:3

71-170-000

Griffe abnehmbar, einfaches Modell
Handles detachable, simple pattern
Manches à détacher, modèle simple
Mango desmontable, modelo simple
Manici demontabili, modello semplice



71-120-000

Komprimeter, bestehend aus Arm- und Oberschenkelmanschette, Manometer justiert bis 700 mm Hg und Metallpumpe
Comprimeter, consisting of arm and upper thigh cuff, manometer calibrated up to 700 mm Hg, with metal pump
Comprimètre se composant du brassard pour bras et cuisse, manomètre calibré jusqu'à 700 mm Hg, avec pompe métallique
Comprimetro, compuesto de brazalete para brazo y muslo, manómetro calibrado hasta 700 mm Hg, con bomba metálica
Comprimetro, composto da torniquete, due bracciali e pompa d'aria e manometro graduato fino a 700 mm Hg

Handbohrapparate
Hand drills

Perforateurs à main
Perforadores de mano
Perforatori a mano



BUNNELL

160 mm – 6 ¼"	66-170-000
---------------	------------

Öffnung bis 4 mm Ø
Opening up to 4 mm Ø
Ouverture jusqu'à 4 mm Ø
Apertura hasta 4 mm Ø
Apertura fino à 4 mm Ø

Leichtmetallgehäuse

Light metal housing
Carcasse en métal léger
Carcasa en metal ligero
In scatola di alluminio

Längsdurchbohrt

Longitudinally cannulated
À perforation axiale
Acanalado longitudinalmente
Forato longitudinalmente

66-170-000/1

Ersatzschlüssel für 66-170-000

Spare key for 66-170-000
Clé de réchange pour 66-170-000
Llave de recambio para 66-170-000
Chiave di ricambio per 66-170-000



RALK

160 mm – 6 ¼"	332-276-000
---------------	-------------

Öffnung bis 6,35 mm Ø
Opening up to 6.35 mm Ø
Ouverture jusqu'à 6.35 mm Ø
Apertura hasta 6.35 mm Ø
Apertura fino à 6.35 mm Ø

Leichtmetallgehäuse

Light metal housing
Carcasse en métal léger
Carcasa en metal ligero
In scatola di alluminio

Längsdurchbohrt

Longitudinally cannulated
À perforation axiale
Acanalado longitudinalmente
Forato longitudinalmente

Handbohrapparate Hand drills

Perforateurs à main
Perforadores de mano
Perforatori a mano



1:2

STILLE

200 mm – 8"	66-120- 100
-------------	----------------

komplett mit 7 Bohrem (Fig. 1 – Fig. 9)
complete with 7 twist drills (Fig. 1 – Fig. 9)
complet avec 7 Mèches (Fig. 1 – Fig. 9)
completa con 7 fresas (Fig. 1 – Fig. 9)
completa con 7 frese (Fig. 1 – Fig. 9)

66-120-000

Handbohrapparat alleine
Hand drill only
Perforateurs à main seul
Perforadores de mano sólo
Perforatori a mano solo



1:2

1:2

1:2

1:2

Fig. 1	Fig. 2	Fig. 3	Fig. 4
2.5 mm Ø	3.0 mm Ø	3.5 mm Ø	4.0 mm Ø
66-120-010	66-120-020	66-120-030	66-120-040



1:2

1:2

1:2

Fig. 7	Fig. 8	Fig. 9
8.0 mm Ø	12.0 mm Ø	16.0 mm Ø
66-120-070	66-120-080	66-120-090



1:2

1:2

1:2

Fig. 10	Fig. 11	Fig. 12
1.0 mm Ø	1.5 mm Ø	2.0 mm Ø
66-120-001	66-120-002	66-120-003

Handbohrapparate
Hand drills
Perforateurs à main
Perforadores de mano
Perforatori a mano

1:2

JACOBS

280 mm – 11 "

421-154-060

Öffnung bis 6.35 mm Ø
 Opening up to 6.35 mm Ø
 Ouverture jusqu'à 6.35 mm Ø
 Apertura hasta 6.35 mm Ø
 Apertura fino à 6.35 mm Ø



1:2

332-292-000

Öffnung bis 6.35 mm Ø
 Opening up to 6.35 mm Ø
 Ouverture jusqu'à 6.35 mm Ø
 Apertura hasta 6.35 mm Ø
 Apertura fino à 6.35 mm Ø

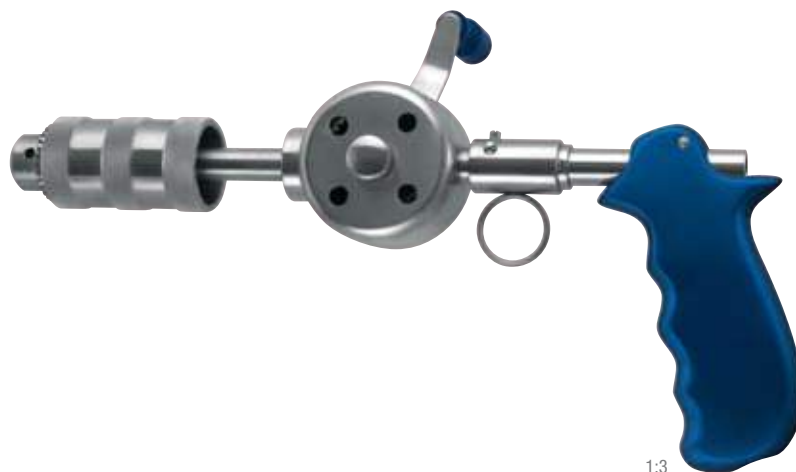

1:3

280 mm – 11 "

66-180-000

Handbohrapparat, rostfrei, beweglicher Griff, mit „Jacobs“-Spannfutter und Schlüssel
 Hand drill, stainless, adjustable handle, with "Jacobs"-chuck and key
 Perceuse mécanique en acier inox, manche mobile, avec mandrin «Jacobs» et clé
 Taladro manual, mango mobil, acero inoxidable, porta brocas "Jacobs" y llave
 Perforatore a mano, inossidabile, manico da muovere, con morso "Jacobs" e chiave

Knochenchirurgie

Bone surgery

09

Spiralbohrer – Pfrieme

Twist drills – Reamers

Mèches – Alênes

Taladros espirales – Escariadores

Punte a spirale – Perforatori a mano



1:2

1:2

1.0 mm Ø		332-350-100
1.5 mm Ø		332-350-150
2.0 mm Ø	332-346-200	332-350-200
2.5 mm Ø	332-346-250	332-350-250
2.8 mm Ø		332-350-280
3.0 mm Ø	332-346-300	332-350-300
3.2 mm Ø	332-346-320	332-350-320
3.5 mm Ø	332-346-350	332-350-350
4.0 mm Ø	332-346-400	332-350-400
5.0 mm Ø	332-346-500	332-350-500
6.0 mm Ø	332-346-600	332-350-600
7.0 mm Ø	332-346-700	332-350-700

AO Schaft

AO shank
Raccord AO
Connector AO
Attaco AO

Rundschaft

Round shank
Tige ronde
Flecha redonda
Asta rotondo



PERTHES

180 mm – 7"	66-190-160
210 mm – 8 ¼"	66-190-210



1:2

140 mm – 5 ½"

421-132-140



1:2

140 mm – 5 ½"

332-388-140