

04

Arterienklemmen

Haemostatic forceps

Pinces hémostatiques

Pinzas hemostáticas

Pinze emostatiche



Arterienklemmen

Haemostatic forceps

Gefäßklemmen

Haemostatic forceps

Serre-fines
Serrafinas
Serrafine



DIEFFENBACH

35 mm – 1 ½ "	12-320-035	12-321-035
50 mm – 2 "	12-320-050	12-321-050
60 mm – 2 ¼ "	12-320-060	12-321-060



JOHNS-HOPKINS

38 mm – 1 ½ "	12-326-038	12-327-038
51 mm – 2 "	12-326-051	12-327-051
57 mm – 2 ¼ "	12-326-057	12-327-057
63 mm – 2 ½ "	12-326-063	12-327-063
70 mm – 2 ¾ "	12-326-070	12-327-070
75 mm – 3 "	12-326-075	12-327-075
90 mm – 3 ½ "	12-326-090	12-327-090

gerade
straight
droit
recta
retto

gebogen
curved
courbe
curva
curvo



DIETRICH

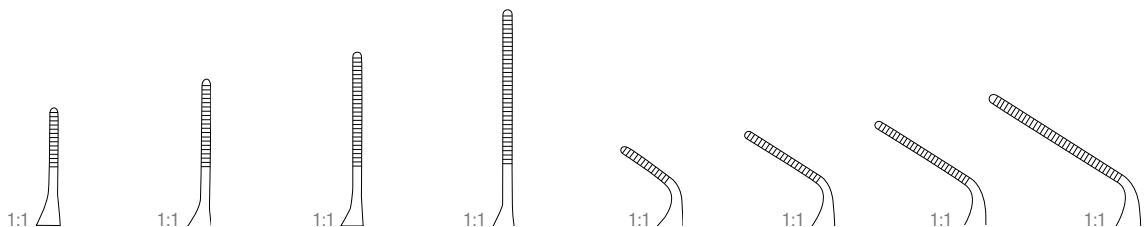

x =	50 mm – 2 "	50 mm – 2 "	50 mm – 2 "	60 mm – 2 ¼ "	50 mm – 2 "	50 mm – 2 "	50 mm – 2 "	60 mm – 2 ¼ "
y =	8 mm	12 mm	16 mm	20 mm	8 mm	12 mm	16 mm	20 mm
	12-450-008	12-450-012	12-450-016	12-450-020	12-451-008	12-451-012	12-451-016	12-451-020

x = Länge
x = Length
x = Longueur
x = longitud
x = Lunghezza

y = geriefte Maullänge
y = serrated jaw part
y = partie striée du mors
y = boca aserrada
y = morso zigrinato

Arterienklemmen
Haemostatic forceps
Pinces hémostatiques
Pinzas hemostáticas
Pinze emostatiche

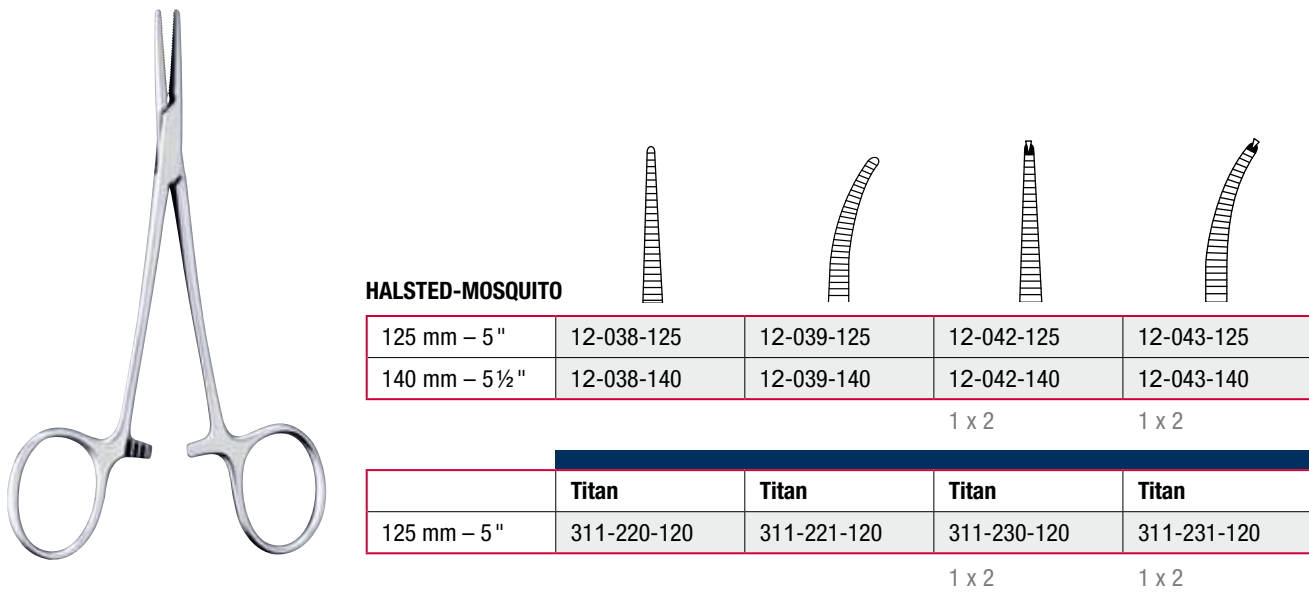
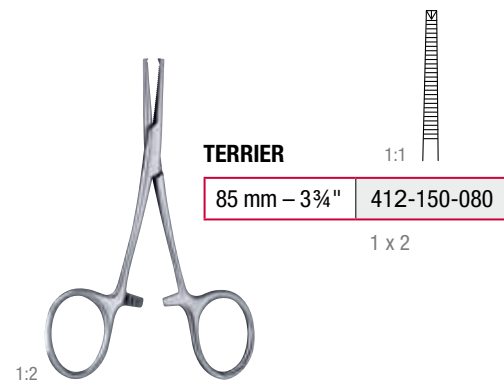
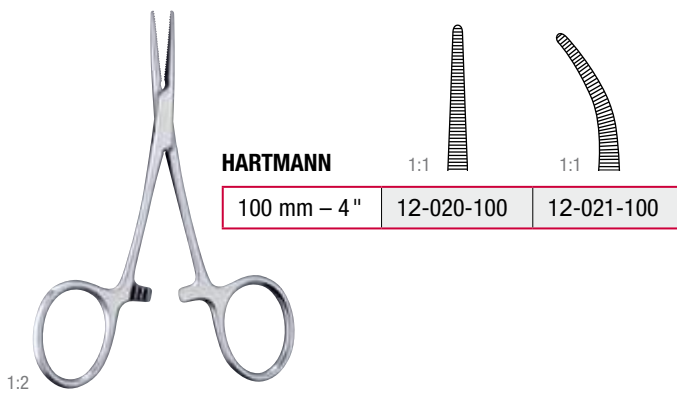

Arterienklemmen

Haemostatic forceps

Arterienklemmen
Haemostatic forceps
Pinces hémostatiques
Pinzas hemostáticas
Pinze emostatiche



MICRO-MOSQUITO

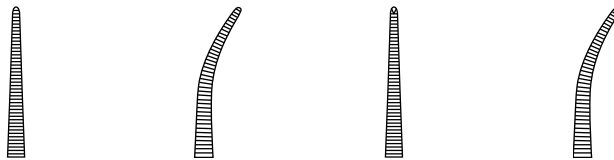

100 mm – 4"	12-028-100	12-029-100	12-030-100	12-031-100
120 mm – 4¾"	12-028-120	12-029-120	12-030-120	12-031-120

1 x 2

1 x 2

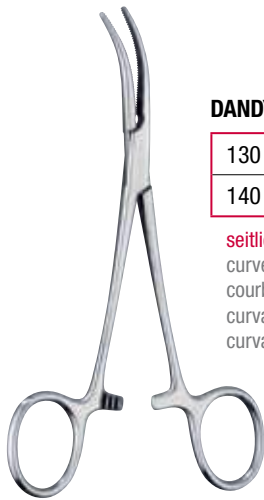

DANDY



130 mm – 4"	12-117-130	
140 mm – 5½"	12-117-140	412-353-140

1 x 2

seitlich gebogen
 curved to the side
 courbe sur le plat
 curva al lado
 curvata lateralmente

MOSQUITO-DANDY



1:1

120 mm – 4¾"	412-347-120
--------------	-------------

seitlich gebogen
 curved to the side
 courbe sur le plat
 curva al lado
 curvata lateralmente

1:2



PROVIDENCE-HOSPITAL

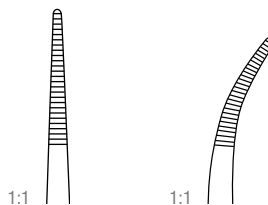

140 mm – 5½"	12-072-140	12-073-140
--------------	------------	------------

1:1

1:1

1:2

Arterienklemmen
Haemostatic forceps
Pinces hémostatiques
Pinzas hemostáticas
Pinze emostatiche



CHRISTOPHE

130 mm – 4"	12-055-130
150 mm – 6"	12-055-150

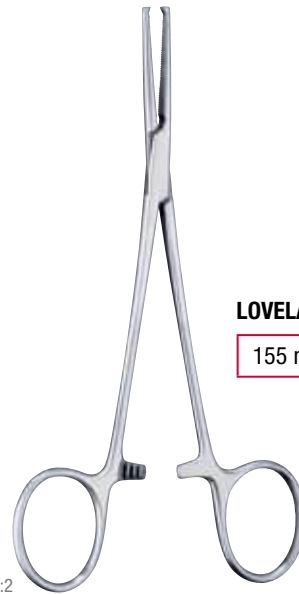
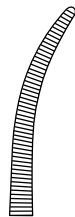

LOVELACE

155 mm – 6"	12-140-155	412-344-150
-------------	------------	-------------

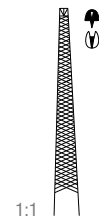

1 x 2

1:2



LERICHE

150 mm – 6"	312-376-150	312-377-150
-------------	-------------	-------------

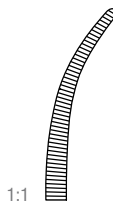
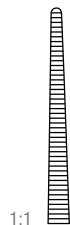

1:1

1:1

1:2



LERICHE

150 mm – 6"	312-378-150	312-379-150
-------------	-------------	-------------

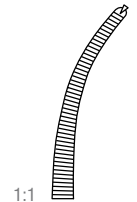

1:1

1:1

1 x 2

1:2

Arterienklemmen

Haemostatic forceps

Arterienklemmen
Haemostatic forceps
Pinces hémostatiques
Pinzas hemostáticas
Pinze emostatiche

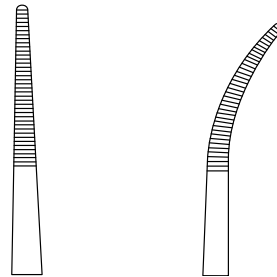

KELLY

140 mm – 5½"	12-078-140	12-079-140
--------------	------------	------------

KELLY-RANKIN

160 mm – 6¼"	12-082-160	12-083-160
--------------	------------	------------

KELLY

	Titan	Titan
140 mm – 5½"	311-240-140	311-241-140

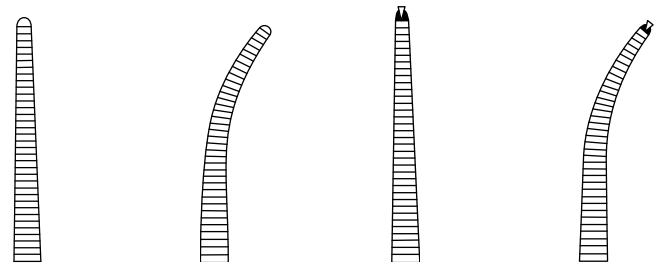

CRILE

140 mm – 5½"	12-090-140	12-091-140	12-092-140	12-093-140
			1 x 2	1 x 2

CRILE-RANKIN

160 mm – 6¼"	12-100-160	12-101-160	311-260-160	311-261-160
			1 x 2	1 x 2

CRILE

	Titan	Titan
140 mm – 5½"	311-250-140	311-251-140

Arterienklemmen

Haemostatic forceps

Pinces hémostatiques
Pinzas hemostáticas
Pinze emostatiche

COLLER-CRILE

140 mm – 5 ½"	311-262-140	311-263-140
160 mm – 6 ¼"	311-262-160	311-263-160

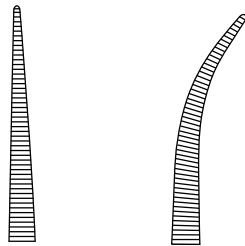

PÉAN

130 mm – 5"	412-370-130	412-371-130
140 mm – 5 ½"	311-308-140	311-309-140
160 mm – 6 ¼"	412-370-160	412-371-160

graziles Modell
 delicate pattern
 modèle délicat
 modelo delicado
 modello delicato

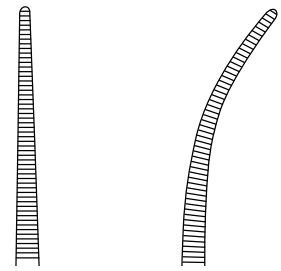

DUNHILL

125 mm – 5"	311-272-130	11-273-130
-------------	-------------	------------

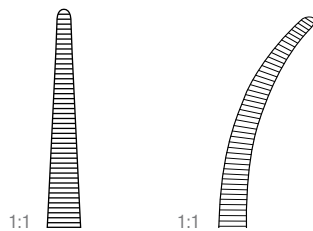

gebogen
 curved
 courbe
 curva
 curvo

CAIRNS

150 mm – 6"	311-270-140	311-271-140
-------------	-------------	-------------



KOCHER

130 mm – 5"	412-380-130	412-381-130
140 mm – 5 ½"	311-318-140	311-319-140
160 mm – 6 ¼"	311-318-160	412-381-160

1 x 2 1 x 2

graziles Modell
 delicate pattern
 modèle délicat
 modelo delicado
 modello delicato

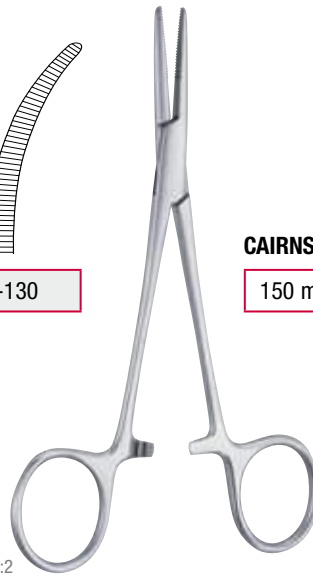
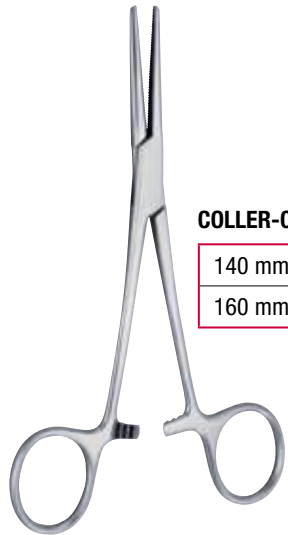
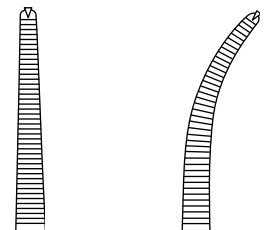

Arterienklemmen

Haemostatic forceps

Arterienklemmen
Haemostatic forceps
Pinces hémostatiques
Pinzas hemostáticas
Pinze emostatiche

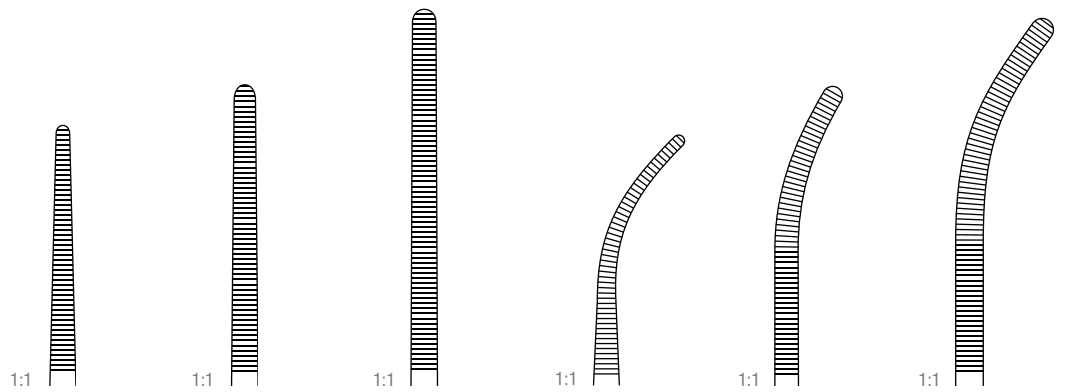

PÉAN-FINO

140 mm – 5 ½ "	165 mm – 6 ½ "	185 mm – 7 ¼ "	140 mm – 5 ½ "	160 mm – 6 ¼ "	180 mm – 7 "
412-376-140	412-376-160	412-376-180	412-377-140	412-377-160	412-377-180

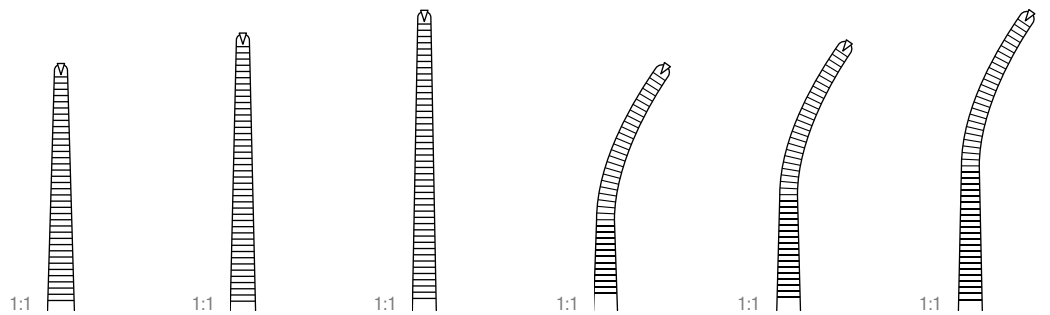

KOCHER-FINO

145 mm – 5 ¾ "	165 mm – 6 ½ "	185 mm – 7 ¼ "	145 mm – 5 ¾ "	160 mm – 6 ¼ "	180 mm – 7 "
412-378-140	412-378-160	412-378-180	412-379-140	412-379-160	412-379-180

1 x 2 1 x 2 1 x 2 1 x 2 1 x 2 1 x 2

Arterienklemmen
 Haemostatic forceps

Pinces hémostatiques
Pinzas hemostáticas
Pinze emostatiche

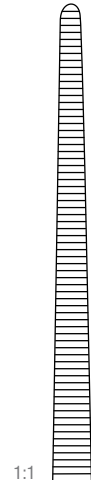
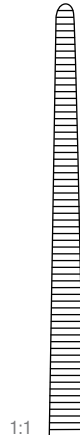
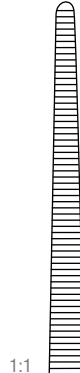
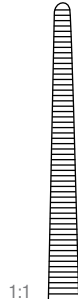
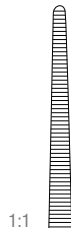
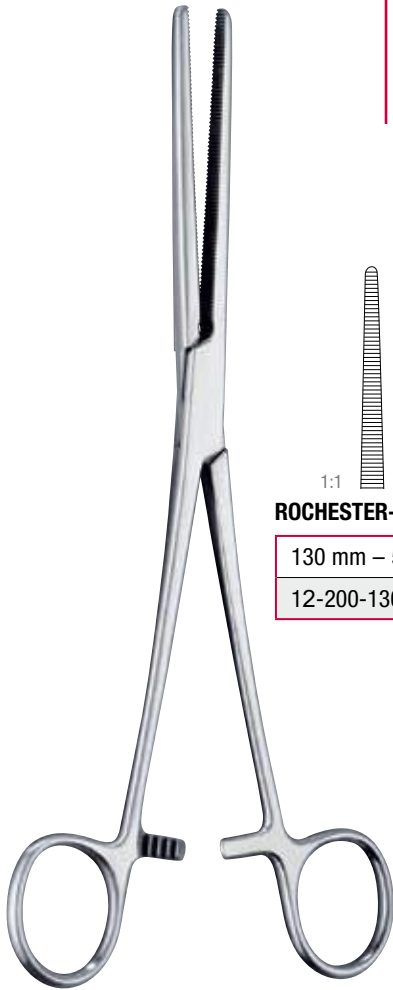

ROCHESTER-PÉAN

130 mm – 5"	140 mm – 5 ½"	160 mm – 6 ¼"	180 mm – 7"	200 mm – 8"
12-200-130	12-200-140	12-200-160	12-200-180	12-200-200

Atrauma	Atrauma	Atrauma	Atrauma
140 mm – 5 ½"	160 mm – 6 ¼"	180 mm – 7"	200 mm – 8"
312-078-140	312-078-160	312-078-180	312-078-200

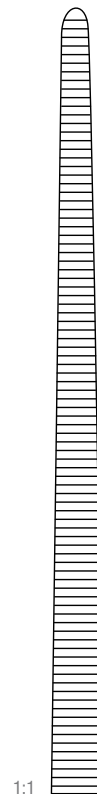
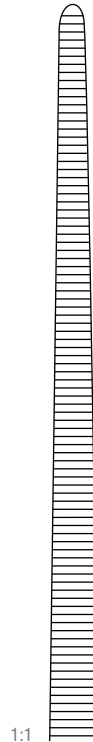
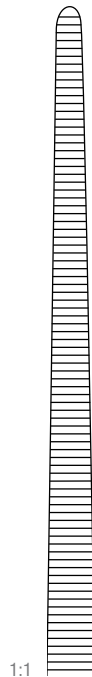
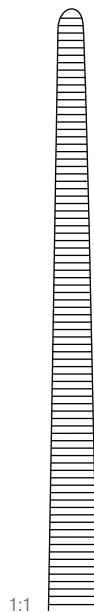
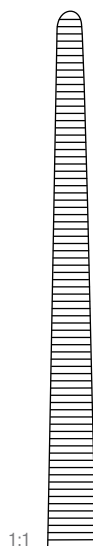

220 mm – 8 ¾"	240 mm – 9 ½"	260 mm – 10 ¼"	300 mm – 12"	350 mm – 14"
12-200-220	12-200-240	12-200-260	12-200-300	12-200-350

Atrauma	Atrauma
260 mm – 10 ¼"	300 mm – 12"
312-078-265	312-078-280

Arterienklemmen

Haemostatic forceps

Arterienklemmen
Haemostatic forceps
Pinces hémostatiques
Pinzas hemostáticas
Pinze emostatiche

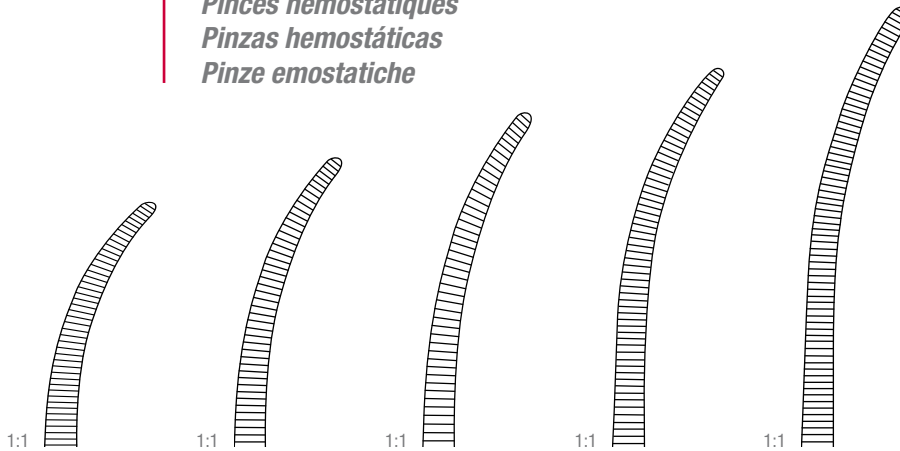

ROCHESTER-PÉAN

130 mm – 5 "	140 mm – 5½ "	160 mm – 6¼ "	180 mm – 7 "	200 mm – 8 "
12-201-130	12-201-140	12-201-160	12-201-180	12-201-200

Atrauma	Atrauma	Atrauma	Atrauma
140 mm – 5½ "	160 mm – 6¼ "	180 mm – 7 "	200 mm – 8 "
312-079-140	312-079-160	312-079-180	312-079-200

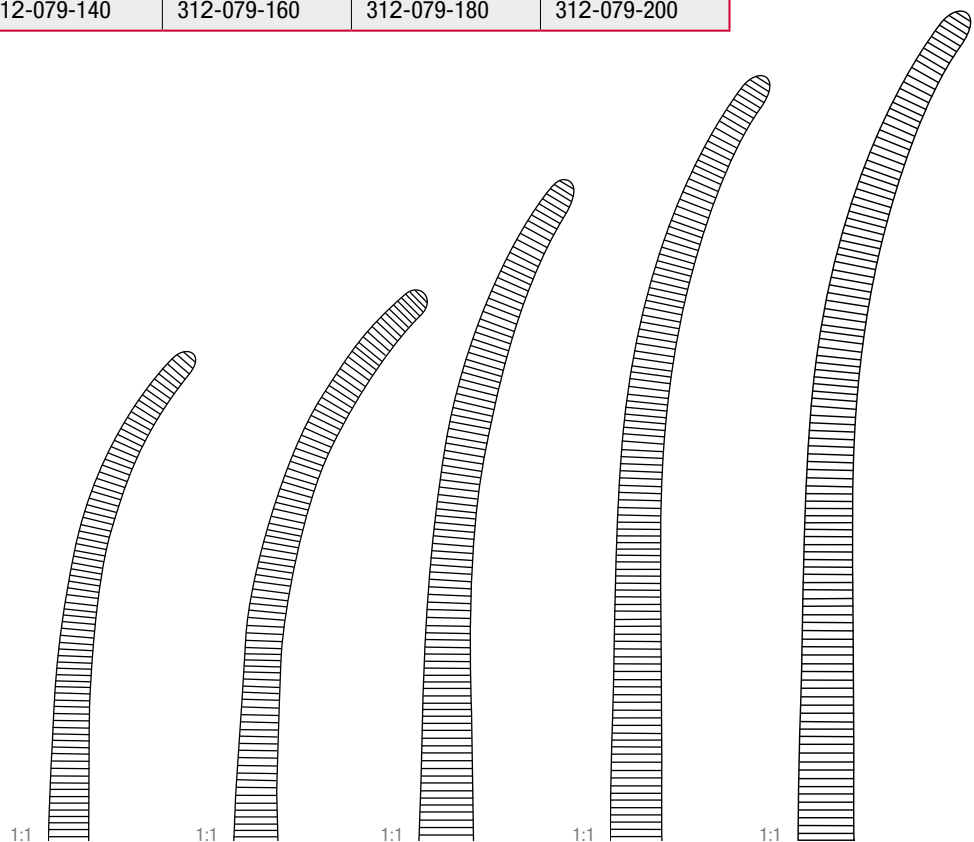

220 mm – 8¾ "	240 mm – 9½ "	260 mm – 10¼ "	300 mm – 12 "	350 mm – 14 "
12-201-220	12-201-240	12-201-260	12-201-300	12-201-350

Atrauma	Atrauma
260 mm – 10¼ "	300 mm – 12 "
312-079-260	312-079-275

Arterienklemmen
Haemostatic forceps

Pinces hémostatiques
Pinzas hemostáticas
Pinze emostatiche

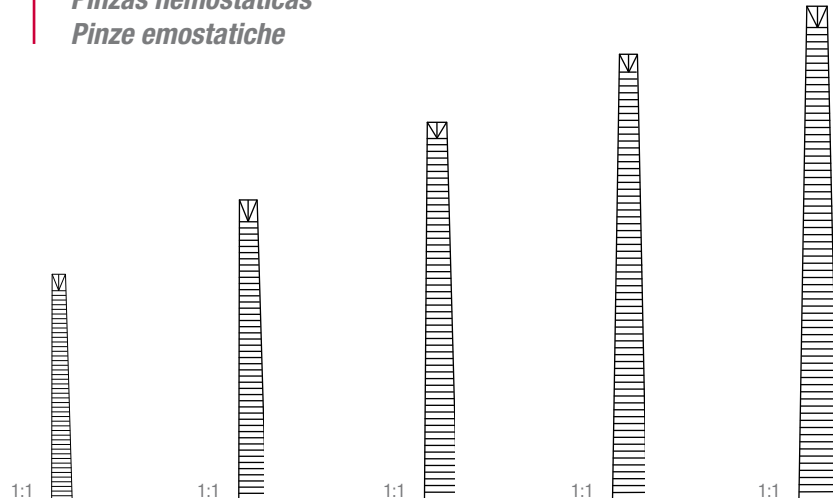

OCHSNER-KOCHER

130 mm – 5"	140 mm – 5½"	160 mm – 6¼"	180 mm – 7"	200 mm – 8"
12-214-130	12-214-140	12-214-160	12-214-180	12-214-200

1 x 2 1 x 2 1 x 2 1 x 2 1 x 2

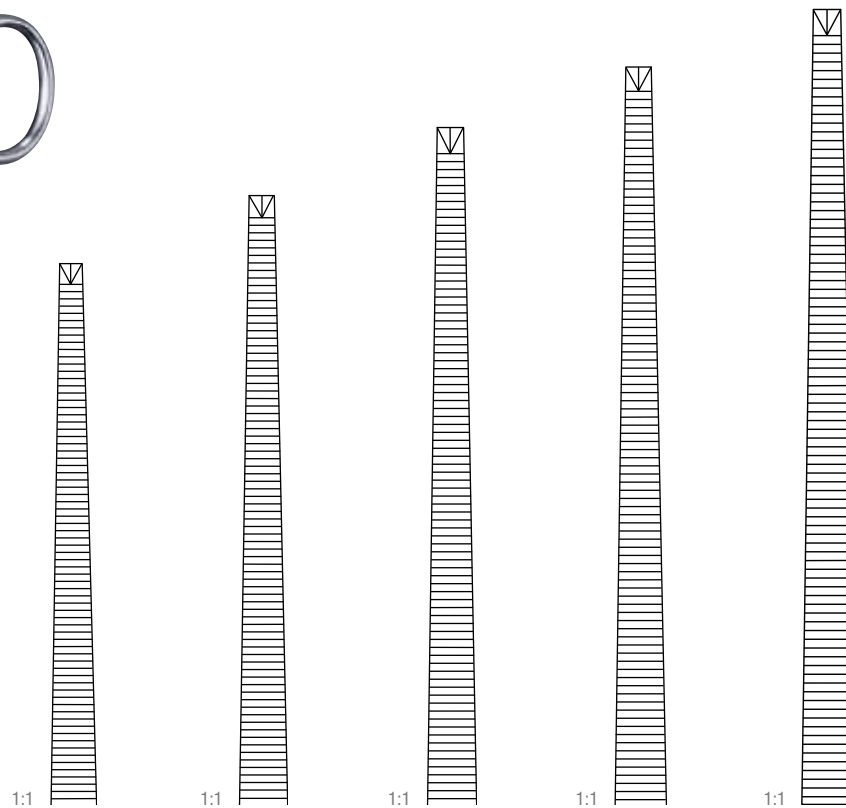

220 mm – 8¾"	240 mm – 9½"	260 mm – 10¼"	300 mm – 12"	300 mm – 14"
12-214-220	12-214-240	12-214-260	12-214-300	12-214-350

1 x 2 1 x 2 1 x 2 1 x 2 1 x 2

Arterienklemmen

Haemostatic forceps

Arterienklemmen
Haemostatic forceps
Pinces hémostatiques
Pinzas hemostáticas
Pinze emostatiche

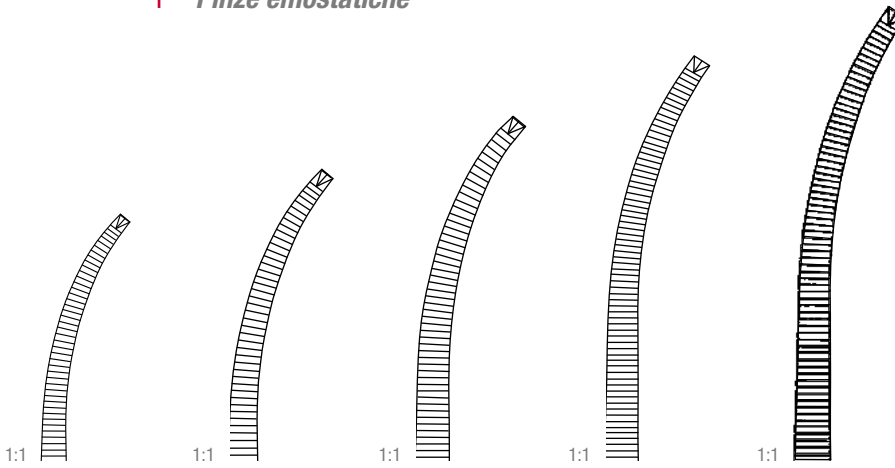

OCHSNER-KOCHER

130 mm – 5"	140 mm – 5½"	160 mm – 6¼"	180 mm – 7"	200 mm – 8"
12-215-130	12-215-140	12-215-160	12-215-180	12-215-200

1 x 2 1 x 2 1 x 2 1 x 2 1 x 2

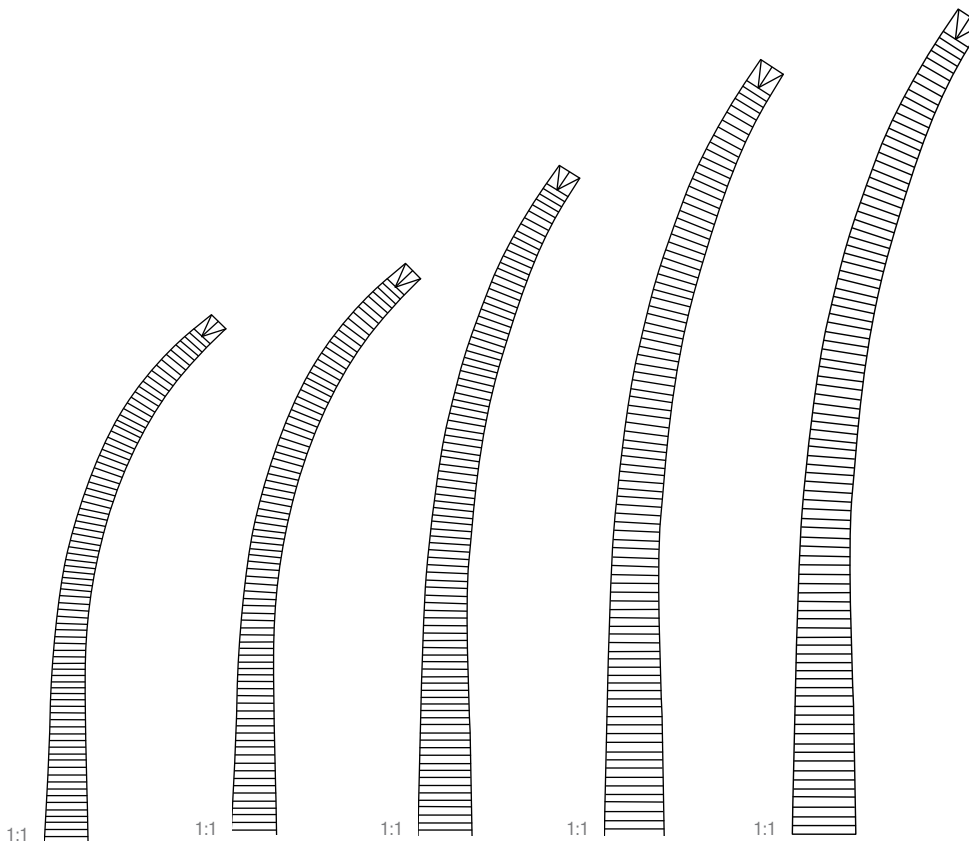

220 mm – 8¾"	240 mm – 9½"	260 mm – 10¼"	300 mm – 12"	350 mm – 14"
12-215-220	12-215-240	12-215-260	12-215-300	12-215-350

1 x 2 1 x 2 1 x 2 1 x 2 1 x 2

Arterienklemmen
Haemostatic forceps
Pinces hémostatiques
Pinzas hemostáticas
Pinze emostatiche



1:2

BIRKETT

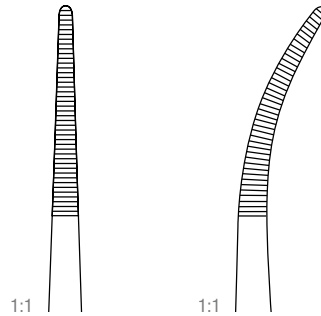

1:1

1:1

190 mm – 7½"	12-228-180	12-229-180
--------------	------------	------------



BAINBRIDGE

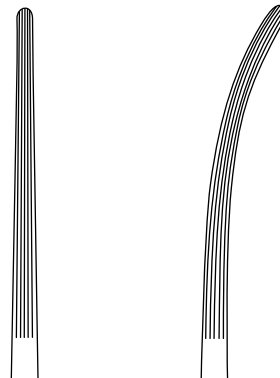

150 mm – 6"	12-148-150	12-149-150
185 mm – 7¼"	12-148-185	12-149-185

Arterienklemmen

Haemostatic forceps

Arterienklemmen
Haemostatic forceps
Pinces hémostatiques
Pinzas hemostáticas
Pinze emostatiche



PÉAN

140 mm – 5 ½ "	12-184-140
160 mm – 6 ¼ "	12-184-160

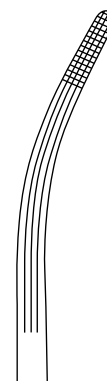

ROCHESTER-CARMALT

160 mm – 6 ¼ "	12-180-160	12-181-160
200 mm – 8 "	12-180-200	12-181-200

Arterienklemmen

Haemostatic forceps

Pinces hémostatiques

Pinzas hemostáticas

Pinze emostatiche

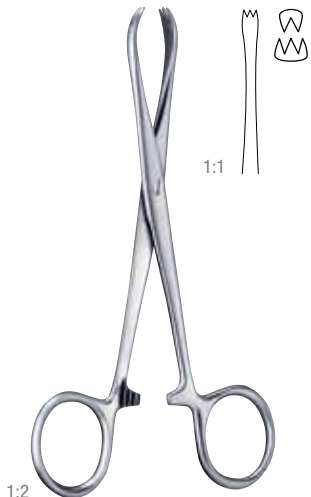

1:2

CHAPUT

130 mm – 5"

311-366-130



1:2

TUFFIER

130 mm – 5"

311-368-130

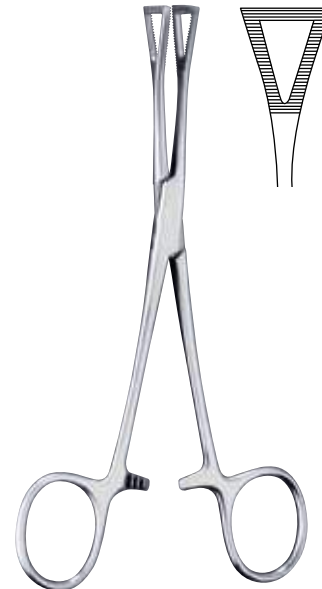

PENNINGTON

155 mm – 6"

12-124-155

200 mm – 8"

12-124-200



1:2

COLLIN

140 mm – 5½"

311-370-140



1:2

PRATT

150 mm – 6"

12-134-150



1:2

MARTEL

140 mm – 5½"

311-360-140

Arterienklemmen

Haemostatic forceps

Arterienklemmen
Haemostatic forceps
Pinces hémostatiques
Pinzas hemostáticas
Pinze emostatiche

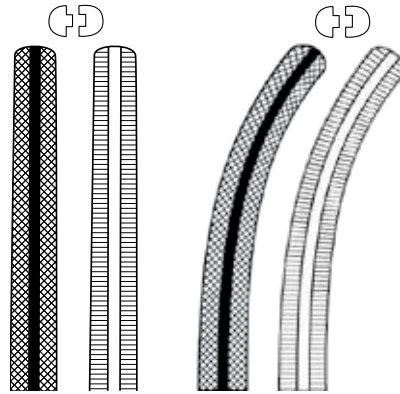

FERGUSSON

160 mm – 6 ¼ "	311-346-160	311-367-160
200 mm – 8 "	311-346-200	311-367-200

gebogen
 curved
 courbe
 curva
 curvo

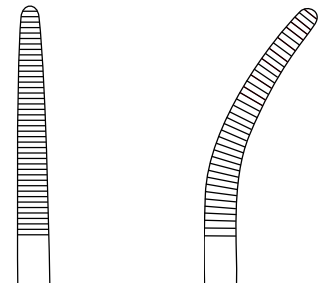

SPENCER-WELLS

130 mm – 5 "	12-190-130	12-191-130
140 mm – 5 ½ "	12-190-140	12-191-140
155 mm – 6 "	12-190-150	12-191-150
180 mm – 7 "	12-190-180	12-191-180
200 mm – 8 "	12-190-200	12-191-200

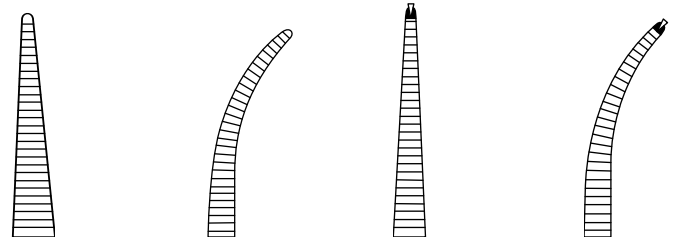

HALSTED-MOSQUITO

180 mm – 7 "	12-048-180	12-049-180	12-050-180	12-051-180
210 mm – 8 ¼ "	311-216-210	311-217-210	311-226-210	311-227-210

1 x 2

1 x 2

Arterienklemmen

Haemostatic forceps

Pinces hémostatiques

Pinzas hemostáticas

Pinze emostatiche

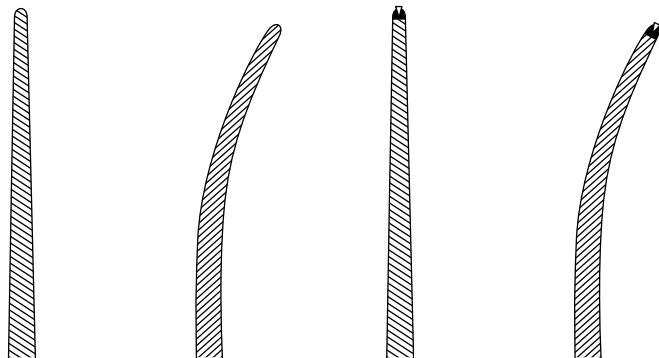

BENGOLEA

200 mm – 8"	12-240-200	12-241-200	12-242-200	12-243-200
260 mm – 10¼"	12-240-260	12-241-260	12-242-260	12-243-260

1 x 2

1 x 2

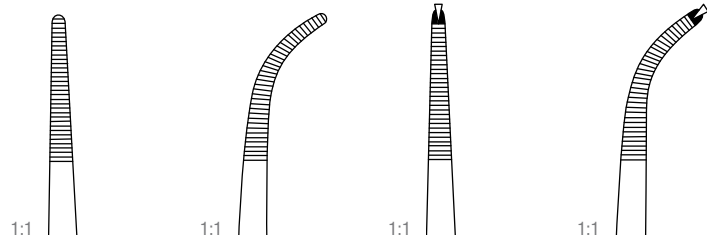

ADSON

185 mm – 7¼"	12-160-185	12-161-185	12-166-185	12-167-185
--------------	------------	------------	------------	------------

1 x 2

1 x 2

1:2

Arterienklemmen

Haemostatic forceps

Arterienklemmen
Haemostatic forceps
Pinces hémostatiques
Pinzas hemostáticas
Pinze emostatiche

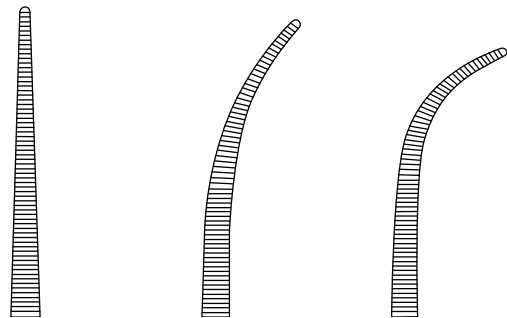

HEISS

200 mm – 8"	12-224-200	12-225-200	12-227-200
230 mm – 9"	12-224-230	12-225-230	12-227-230

Arterienklemmen
Haemostatic forceps
Pinces hémostatiques
Pinzas hemostáticas
Pinze emostatiche



BABY-MIXTER

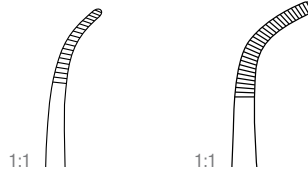

140 mm – 5 ½"	311-471-140	
180 mm – 7"		311-471-180



BABY-ADSON

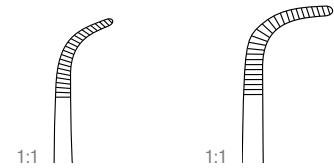

140 mm – 5 ½"	412-417-140	
180 mm – 7"		311-411-180

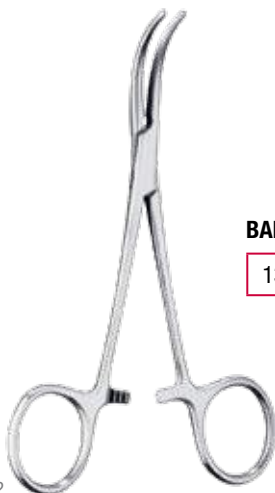

BABY-OVERHOLT

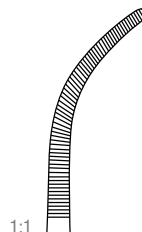

135 mm – 5 ¼"	412-335-140
---------------	-------------

1:2

Arterienklemmen

Haemostatic forceps

Arterienklemmen
Haemostatic forceps
Pinces hémostatiques
Pinzas hemostáticas
Pinze emostatiche

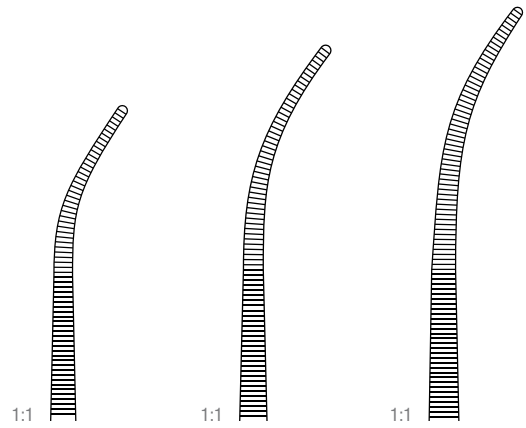
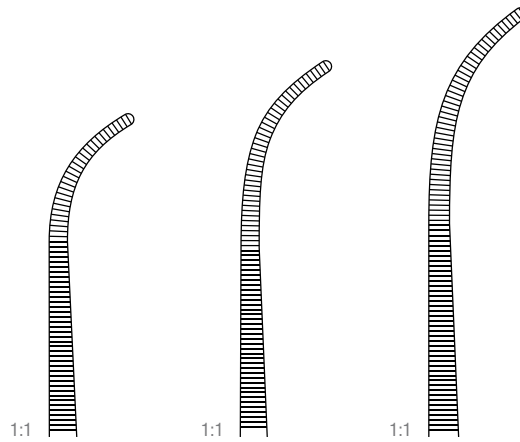

Fig. 1	Fig. 1	Fig. 1
195 mm – 7 ¾"	225 mm – 8 ¾"	245 mm – 9 ¾"
412-573-190	412-573-220	412-573-240



KELLY-FRASER

Fig. 2	Fig. 2	Fig. 2
190 mm – 7 ½"	220 mm – 8 ¾"	240 mm – 9 ½"
412-575-190	412-575-220	412-575-240

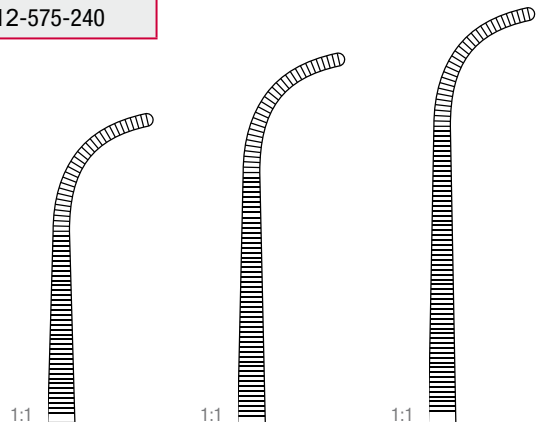

Fig. 3	Fig. 3	Fig. 3
185 mm – 7 ¼"	215 mm – 8 ½"	235 mm – 9 ¼"
412-577-190	412-577-220	412-577-240

Arterienklemmen
Haemostatic forceps
Pinces hémostatiques
Pinzas hemostáticas
Pinze emostatiche



1:2

SCHNIDT

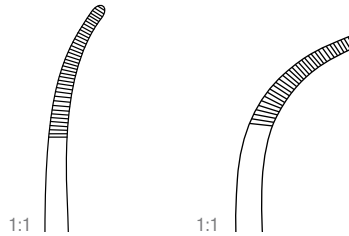

190 mm – 7 ½"	12-531-190	12-533-190
---------------	------------	------------



TOENNIS

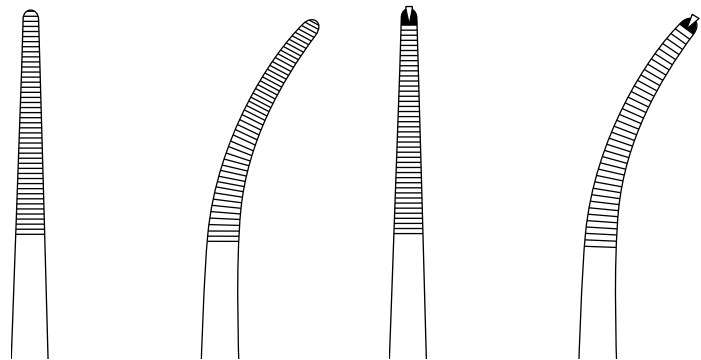

210 mm – 8 ¼"	311-438-210	311-439-210	311-440-210	311-441-210
260 mm – 10 ¼"	311-438-260	311-439-260	311-440-260	311-441-260

1 x 2

1 x 2

Arterienklemmen

Haemostatic forceps

Arterienklemmen
Haemostatic forceps
Pinces hémostatiques
Pinzas hemostáticas
Pinze emostatiche

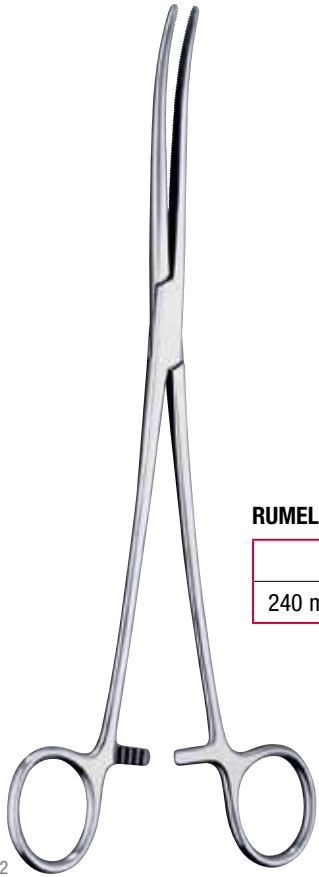

1:2

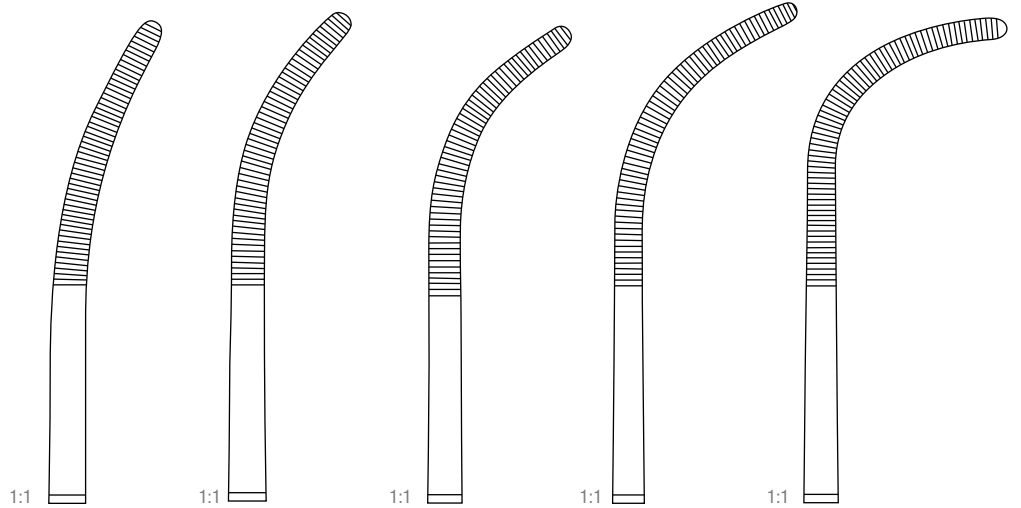

RUMEL

	Fig. 1	Fig. 2	Fig. 3	Fig. 4	Fig. 5
240 mm – 9½"	12-485-001	12-485-002	12-485-003	12-485-004	12-485-005

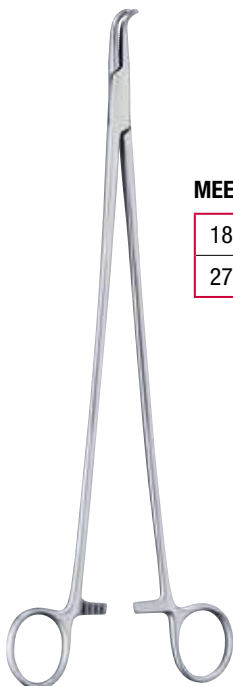

MEEKER

180 mm – 7"	311-455-180
275 mm – 10¾"	311-455-280

gebogen, 90°
 curved, 90°
 courbe, 90°
 curva, 90°
 curve, 90°

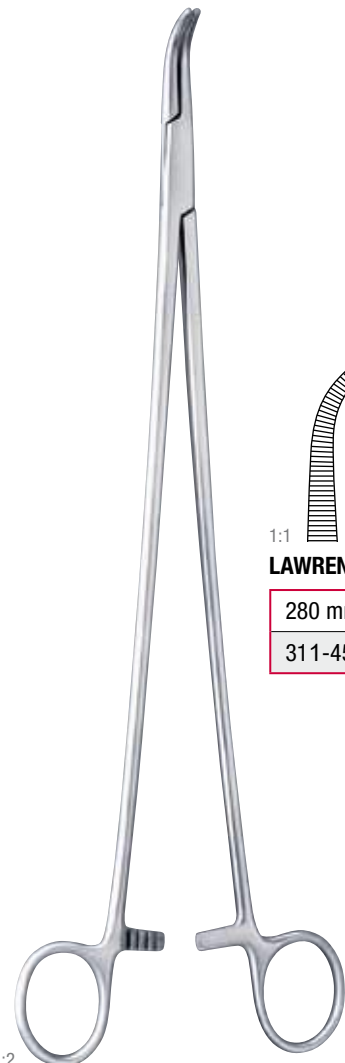
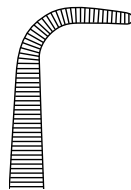

1:2

1:1

LAWRENCE

280 mm – 11"
311-453-280

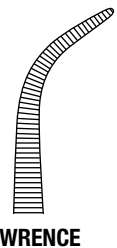

Präparier- und Ligaturklemmen

Dissecting and ligature forceps

Pinces à disséquer et à sutures
Pinzas para preparación y suturas
Pinze per preparazioni e suture



**OVERHOLT-
GEISSENDOERFER**

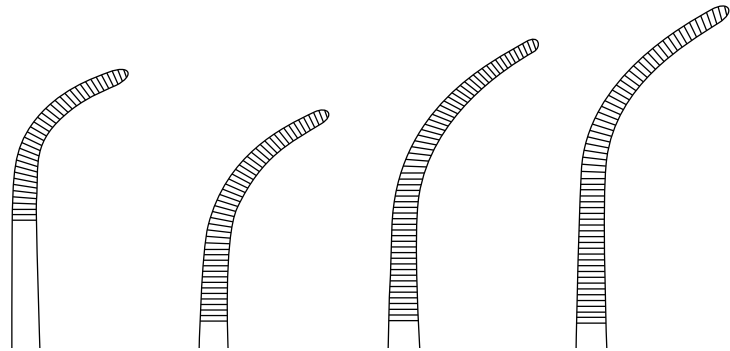

	Fig. 1	Fig. 2	Fig. 3	Fig. 4
210 mm – 8 ¼"	12-469-001	12-469-002	12-469-003	12-469-004
270 mm – 10 ¾"	311-423-010	311-423-020	311-423-030	311-423-040

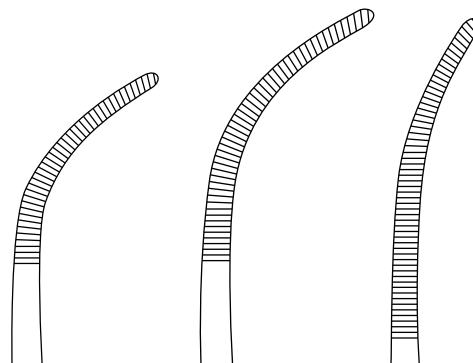

	Fig. 5	Fig. 6	Fig. 7
210 mm – 8 ¼"	12-469-005	12-469-006	12-469-007
270 mm – 10 ¾"	311-423-050	311-423-060	311-423-070

Arterienklemmen

Haemostatic forceps

Präparier- und Ligaturklemmen

Dissecting and ligature forceps

Pinces à disséquer et à sutures
Pinzas para preparación y suturas
Pinze per preparazioni e suture

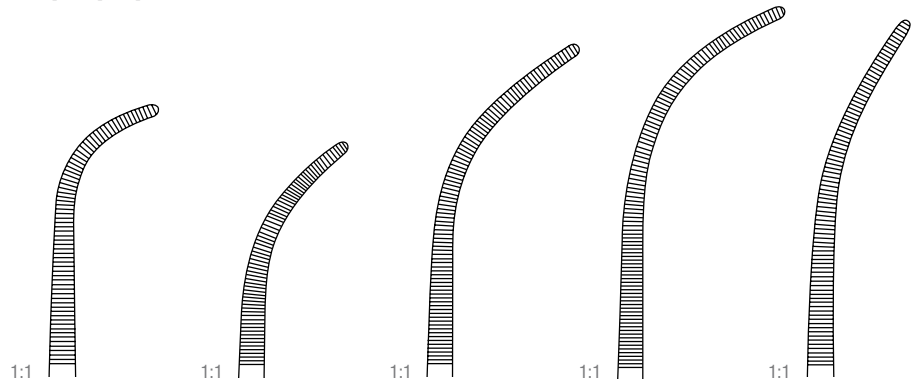

OVERHOLT-FINO

Fig. 0	Fig. 1	Fig. 2	Fig. 3	Fig. 6
215 mm – 8½"	210 mm – 8¼"	220 mm – 8¾"	230 mm – 9"	225 mm – 8¾"
12-471-000	12-471-001	12-471-002	12-471-003	12-471-006

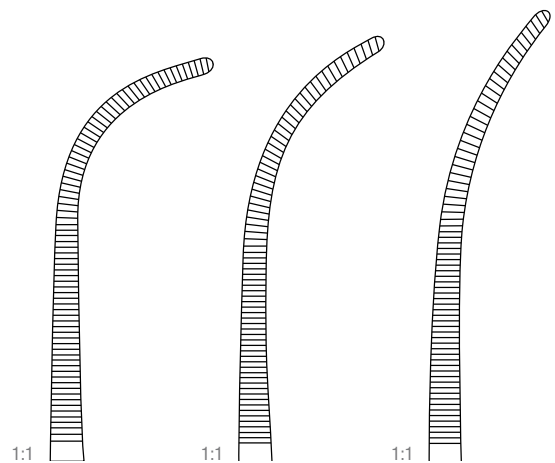

OVERHOLT

Fig. 0	Fig. 1	Fig. 6
295 mm – 8½"	295 mm – 8½"	300 mm – 8¾"
311-425-000	311-425-001	311-425-006

Präparier- und Ligaturklemmen

Dissecting and ligature forceps

Pinces à disséquer et à sutures
Pinzas para preparación y suturas
Pinze per preparazioni e suture

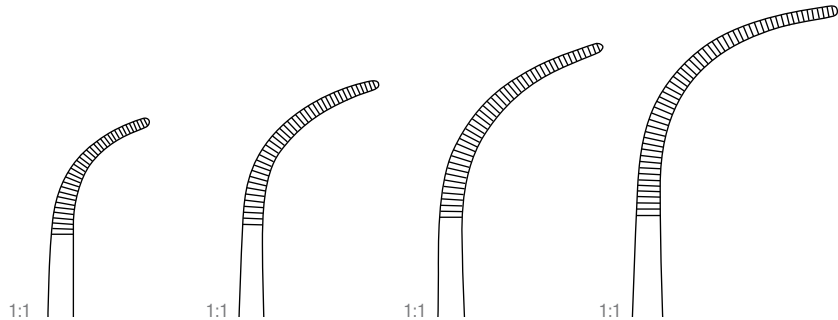

OVERHOLT-MODIFIZIERT

185 mm – 7 ¼ "	205 mm – 8 "	210 mm – 8 ¼ "	215 mm – 8 ½ "
412-413-010	412-413-020	412-413-030	412-413-040

S-förmig gebogen
 S-curved
 courbe en S
 curva en S
 curve a forma di S



OVERHOLT-MIXTER

210 mm – 8 ¼ "	412-423-210
----------------	-------------

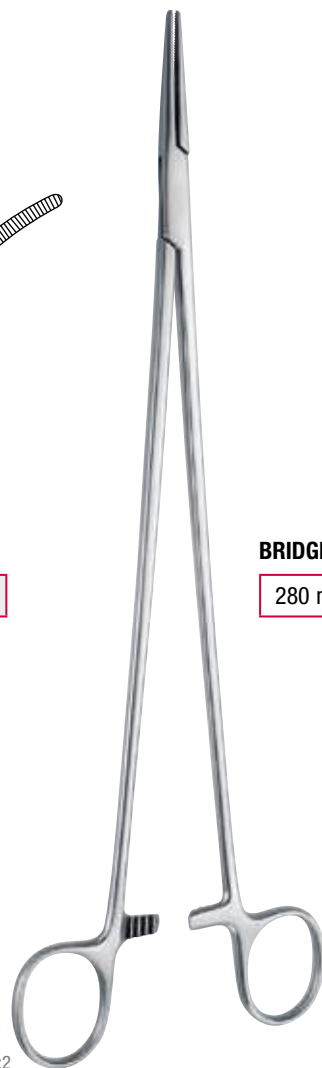
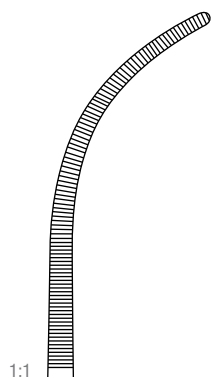

BRIDGE

280 mm – 11 "	311-452-275	311-453-275
---------------	-------------	-------------

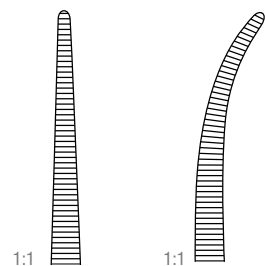

1:2

1:2

Arterienklemmen

Haemostatic forceps

Präparier- und Ligaturklemmen

Dissecting and ligature forceps

Pinces à disséquer et à sutures
Pinzas para preparación y suturas
Pinze per preparazioni e suture

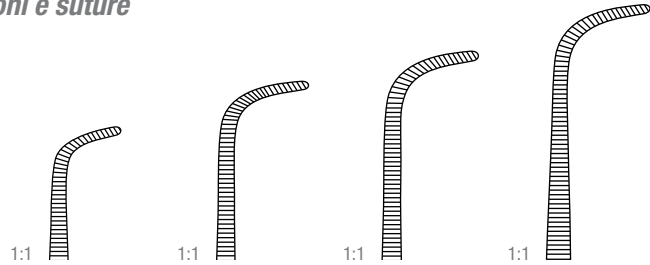

GEMINI

130 mm – 5"	160 mm – 6¼"	180 mm – 7"	200 mm – 8"
311-427-130	311-427-160	311-427-180	311-427-200

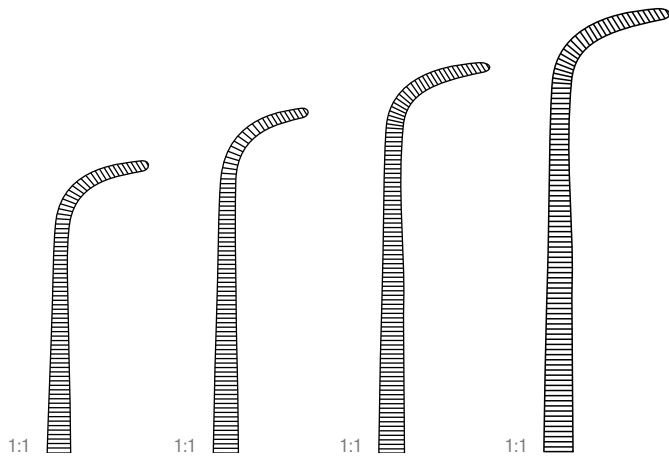

230 mm – 9"	250 mm – 9¾"	280 mm – 11"	350 mm – 14"
311-427-230	311-427-250	311-427-280	311-427-350

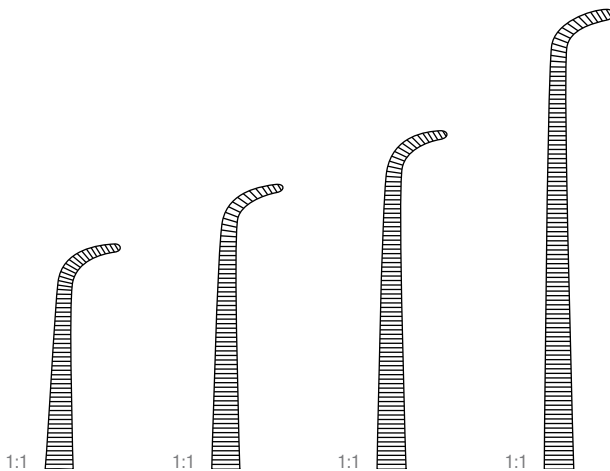

GEMINI-MINI

180 mm – 7"	220 mm – 8¾"	250 mm – 9¾"	280 mm – 11"
311-429-180	311-429-220	311-429-250	311-429-280

Präparier- und Ligaturklemmen
Dissecting and ligature forceps

Pinces à disséquer et à sutures
Pinzas para preparación y suturas
Pinze per preparazioni e suture



1:2

ZENKER

1:1

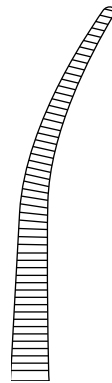

1:1

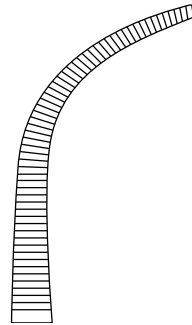

295 mm – 11 ½"

311-451-010

311-451-020



1:2

ROBERTS

1:1



1:1

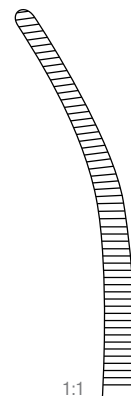

220 mm – 8 ¾"

12-268-220

12-269-220

Arterienklemmen

Haemostatic forceps

Präparier- und Ligaturklemmen
Dissecting and ligature forceps
Pinces à disséquer et à sutures
Pinzas para preparación y suturas
Pinze per preparazioni e suture



MIXTER

140 mm – 6"	311-467-140
155 mm – 6"	311-467-160
190 mm – 7 ½"	311-467-180
230 mm – 9"	311-467-230

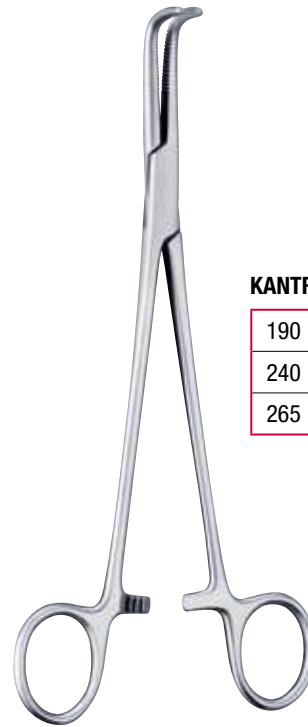
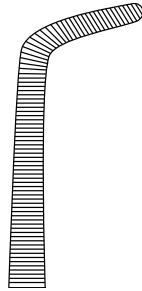

KANTROWITZ

190 mm – 7 ½"	311-457-190
240 mm – 9 ½"	311-457-240
265 mm – 10 ½"	311-457-265

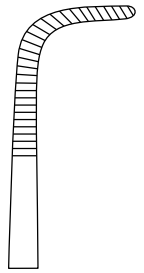

MIXTER

230 mm – 9"	12-557-230
-------------	------------

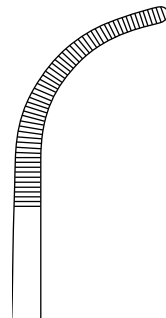

Präparier- und Ligaturklemmen
Dissecting and ligature forceps

Pinces à disséquer et à sutures
Pinzas para preparación y suturas
Pinze per preparazioni e suture



1:2

MIXTER

230 mm – 9"

412-481-230

1:1

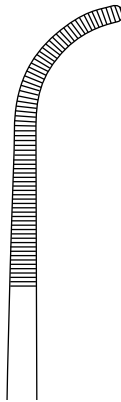

1:2

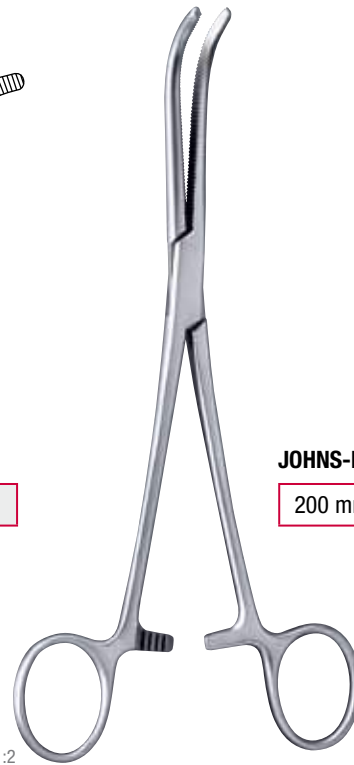

JOHNS-HOPKINS

200 mm – 8"

311-493-200

1:1

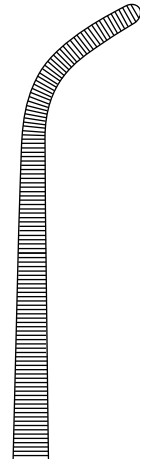

MIXTER-O'SHAUGHNESSY

155 mm – 6"

311-473-150

190 mm – 7½"

311-473-190

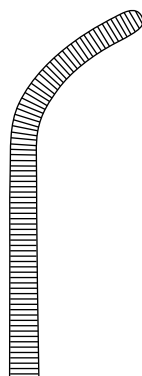

Arterienklemmen

Haemostatic forceps

Präparier- und Ligaturklemmen
Dissecting and ligature forceps
Pinces à disséquer et à sutures
Pinzas para preparación y suturas
Pinze per preparazioni e suture



WICKSTRÖM

210 mm – 8 ¼"	412-483-210
240 mm – 9 ½"	412-483-240

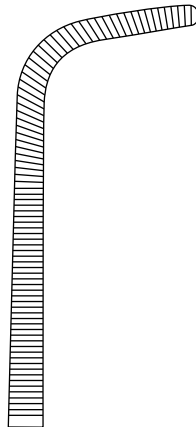

CRAFOORD

180 mm – 7"	412-435-180
240 mm – 9 ½"	12-261-240

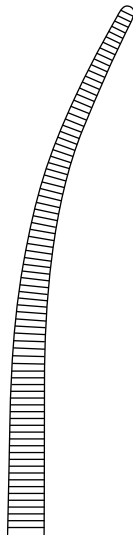

SAROT

240 mm – 9 ½"	12-274-240	12-275-240
---------------	------------	------------

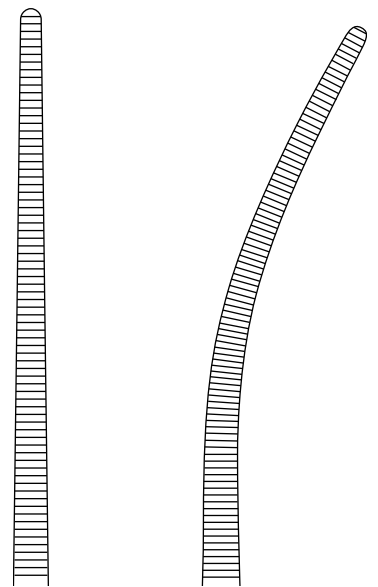

Präparier- und Ligaturklemmen
Dissecting and ligature forceps

Pinces à disséquer et à sutures
Pinzas para preparación y suturas
Pinze per preparazioni e suture



DEAN-SHALLCROSS

1:1

180 mm – 7"

412-583-180

1:2

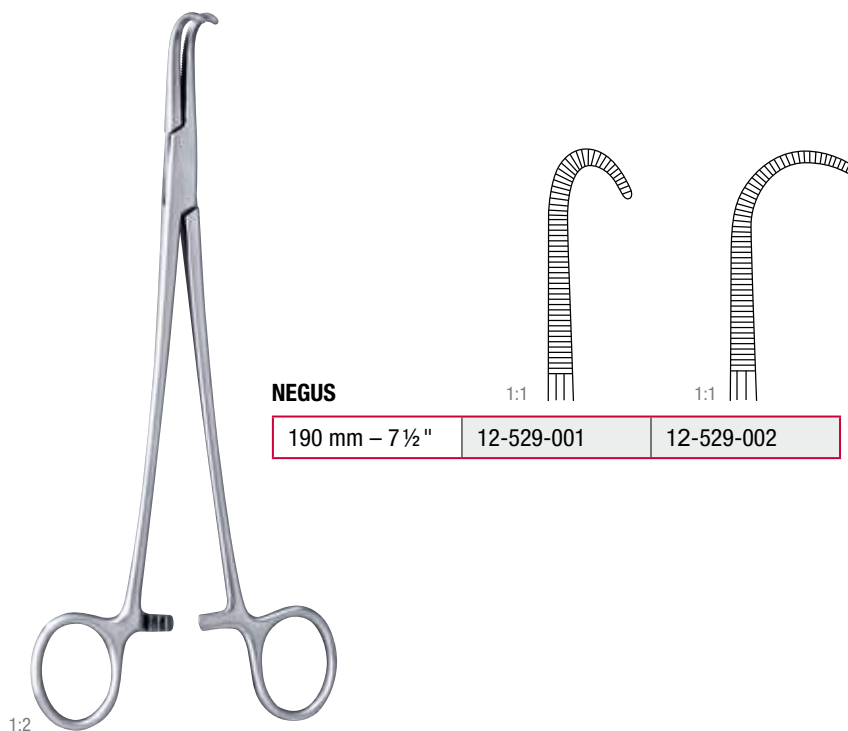

NEGUS

1:1

1:1

190 mm – 7 ½"

12-529-001

12-529-002

1:2

Arterienklemmen

Haemostatic forceps

Gallenkanal- und Nierenstielklemmen

Kidney pedicle and gall duct forceps

Pinces pour pédicules renaux et voies biliaires
Pinzas para pedículos renales y conductos biliares
Pinze per peduncoli renali e vie biliari



1:2

LOWER

180 mm – 7"

311-491-180

1:1

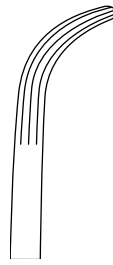

LAHEY

190 mm – 7½"

12-623-190

230 mm – 9"

12-625-235

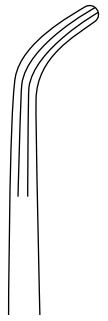

1:2

MCQUIGG-MIXTER

220 mm – 8¾"

412-493-220

1:1

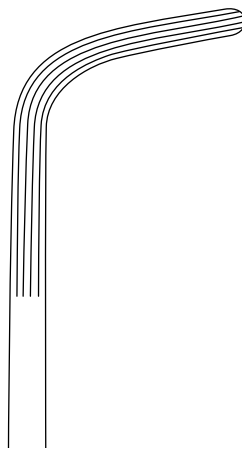

Gallenkanal- und Nierenstielklemmen
Kidney pedicle and gall duct forceps

Pinces pour pédicules renaux et voies biliaires
Pinzas para pedículos renales y conductos biliares
Pinze per peduncoli renali e vie biliari

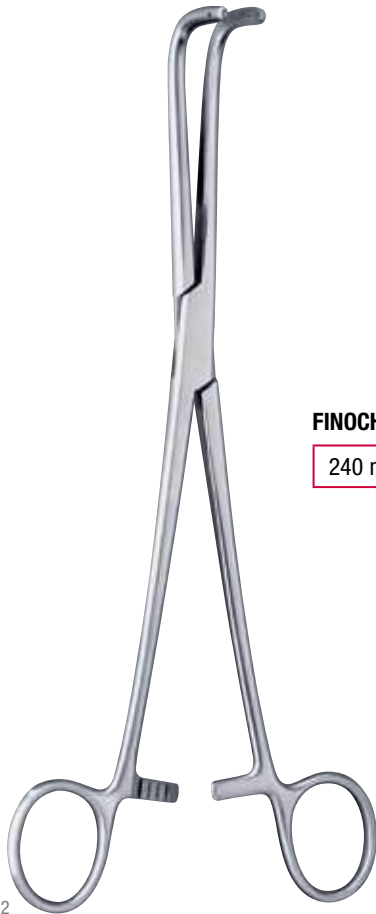

FINOCHIETTO

240 mm – 9 1/2 "

355-303-240

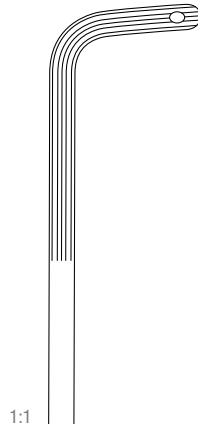

1:1

1:2



MIXTER

220 mm – 8 3/4 "

250 mm – 9 3/4 "

280 mm – 11 "

12-561-230

12-563-250

12-565-280

1:1

1:1

1:1

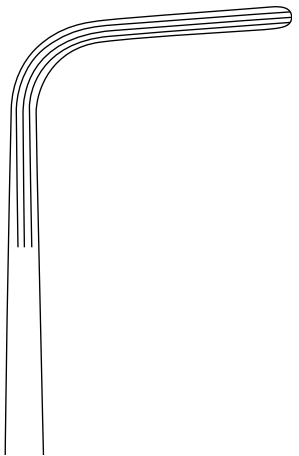
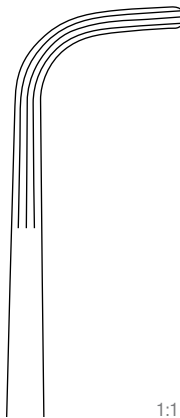
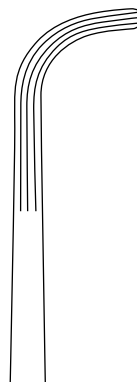

Arterienklemmen

Haemostatic forceps

Gallenkanal- und Nierenstielklemmen

Kidney pedicle and gall duct forceps

Pinces pour pédicules renaux et voies biliaires
Pinzas para pedículos renales y conductos biliares
Pinze per peduncoli renali e vie biliari

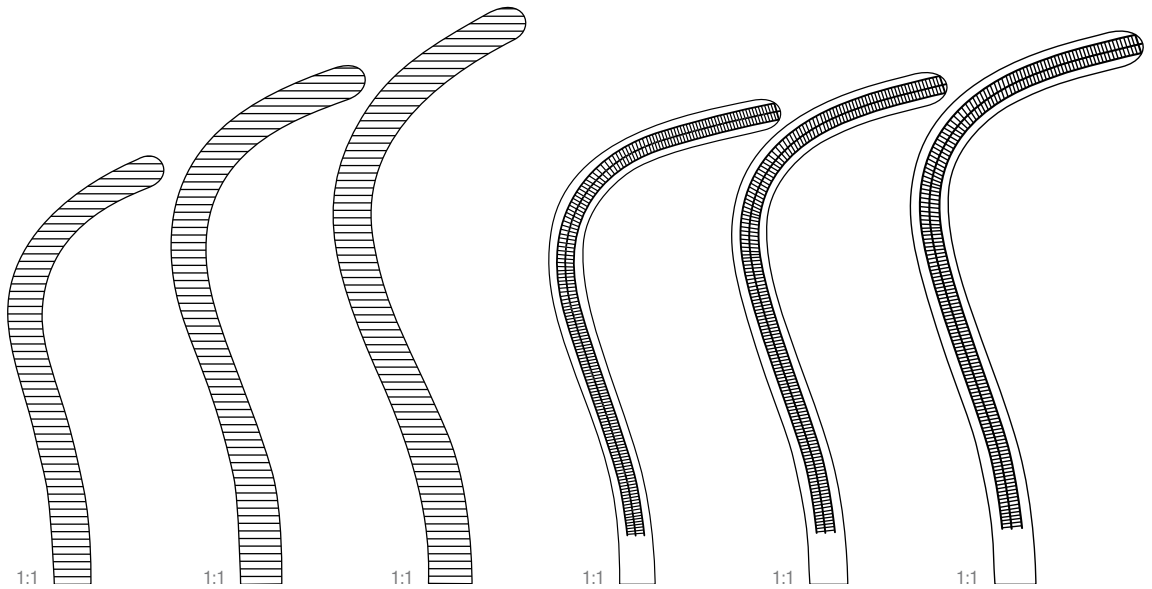

GUYON

			Atrauma	Atrauma	Atrauma
200 mm – 8"	220 mm – 8¾"	240 mm – 9½"	225 mm – 9"	230 mm – 9"	240 mm – 9½"
311-515-200	311-515-220	311-515-240	412-525-225	412-525-230	412-525-240



Nierenstielklemmen
Kidney pedicle forceps

Pinces pour pédicules renaux
Pinzas para pedículos renales
Pinze per peduncoli renali



1:2

HERRICK 1:1

230 mm – 9"	311-519-230
-------------	-------------

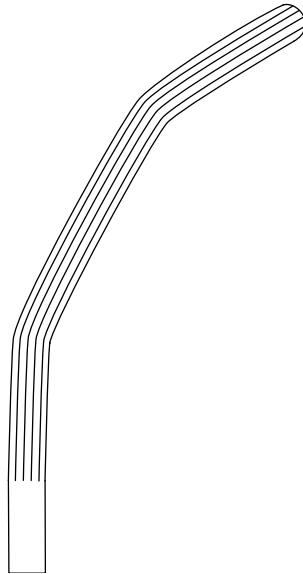

1:2

GUYON 1:1

230 mm – 9"	311-513-230
-------------	-------------

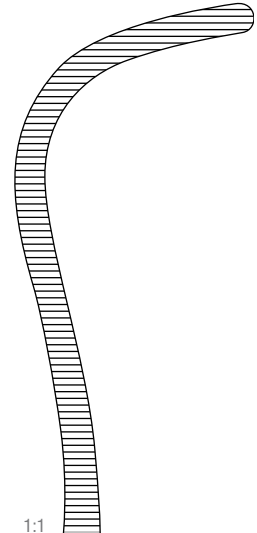

1:2

MAYO-GUYON 1:1

230 mm – 9"	311-511-230
-------------	-------------

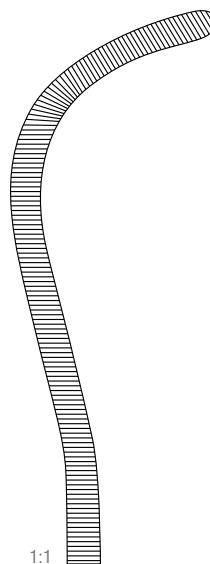

Arterienklemmen

Haemostatic forceps

Klemmzangen – Peritoneumklemmen

Clamp forceps – Peritoneal forceps

Pinces-clamps – Pincés pour le péritoine

Pinzas-clamps – Pinzas para perit6neo

Pinze per peritoneo



1:2

FAURE

200 mm – 8"

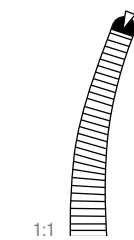

1:1

1 x 2

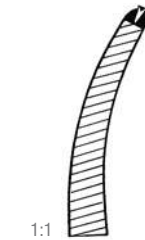

1:1

1 x 2

12-721-210	12-723-210
------------	------------



WERTHEIM

220 mm – 8¾"

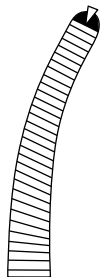

1 x 2

230 mm – 9"

311-569-220	311-571-230
-------------	-------------

Klemmzangen – Peritoneumklemmen

Clamp forceps – Peritoneal forceps

Pinces-clamps – Pinces pour le péritoine

Pinzas-clamps – Pinzas para peritóneo

Pinze per peritoneo



PHANEUF

215 mm – 8 ½"

12-280-200

12-281-200

1 x 2

1 x 2

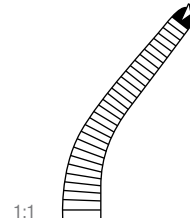
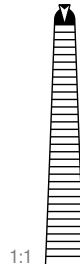

MOYNIHAN

230 mm – 9"

240 mm – 9 ½"

12-645-225

12-647-235

1:1

1:1

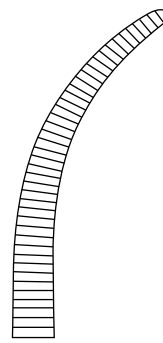
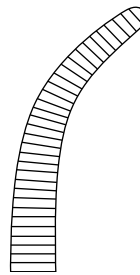

Arterienklemmen

Haemostatic forceps

Klemmzangen – Peritoneumklemmen

Clamp forceps – Peritoneal forceps

Pinces-clamps – Pincés pour le péritoine

Pinzas-clamps – Pinzas para perit6neo

Pinze per peritoneo



Klemmzangen – Peritoneumklemmen

Clamp forceps – Peritoneal forceps

Pinces-clamps – Pinces pour le péritoine

Pinzas-clamps – Pinzas para peritóneo

Pinze per peritoneo



MAINGOT

205 mm – 8"	12-685-200
250 mm – 9¾"	12-685-250

1 x 2

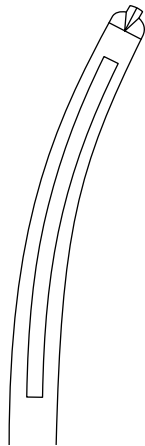

WERTHEIM

250 mm – 9¾"	12-681-250
--------------	------------

1:1

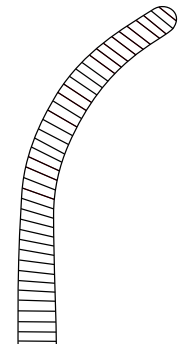

1:2

1:1

WERTHEIM-CULLEN

215 mm – 8½"	311-575-210
--------------	-------------

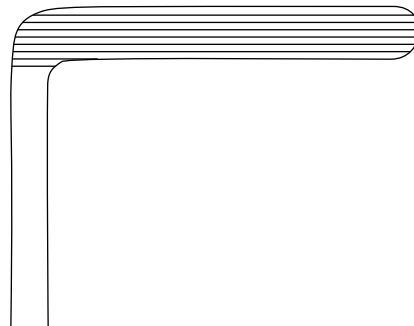

Arterienklemmen

Haemostatic forceps

04

Hysterektomieklemmen

Hysterectomy forceps

Pinces pour hystérectomie
Pinzas para histerectomía
Pinze per isterectomia



HEANEY

195 mm – 7¾"	12-905-195	12-907-195
210 mm – 8¼"	12-905-210	12-907-210
230 mm – 9"	12-905-230	12-907-230

Hysterektomieklemmen
Hysterectomy forceps

Pinces pour hystérectomie
Pinzas para histerectomía
Pinze per isterectomia



HEANEY-BALLENTINE

1:1



1:1

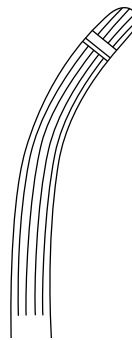

210 mm – 8 ¼"

12-908-210

12-909-210

Arterienklemmen

Haemostatic forceps

Parametriumklemmen
Parametrium forceps
Pinces parametrium
Pinzas parametrium
Pinze parametrium

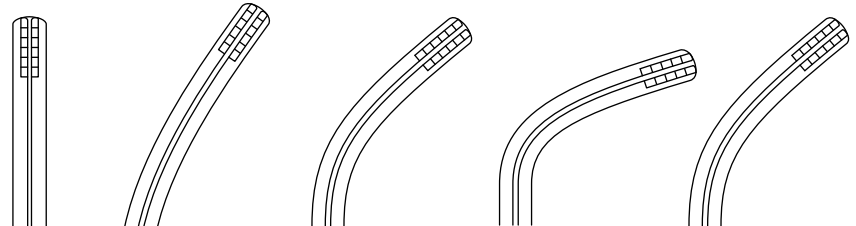

210 mm – 8 ¼"	12-913-210	12-915-210	12-917-210	12-919-210	12-921-210
240 mm – 9 ½"	12-913-240	12-915-240	12-917-240	12-919-240	12-921-240
260 mm – 10 ¼"	12-913-260	12-915-260	12-917-260	12-919-260	12-921-260
300 mm – 12"	12-913-300	12-915-300	12-917-300	12-919-300	12-921-300
350 mm – 13 ¾"	12-913-350	12-915-350	12-917-350	12-919-350	12-921-350

S-förmig gebogen
 S-curved
 coube en S
 curva en S
 curva a forma di S

Lungenfasszangen

Lung grasping forceps

Pinces-clamps pour poumons

Pinzas para coger pulmones

Pinza per afferrare il polmone

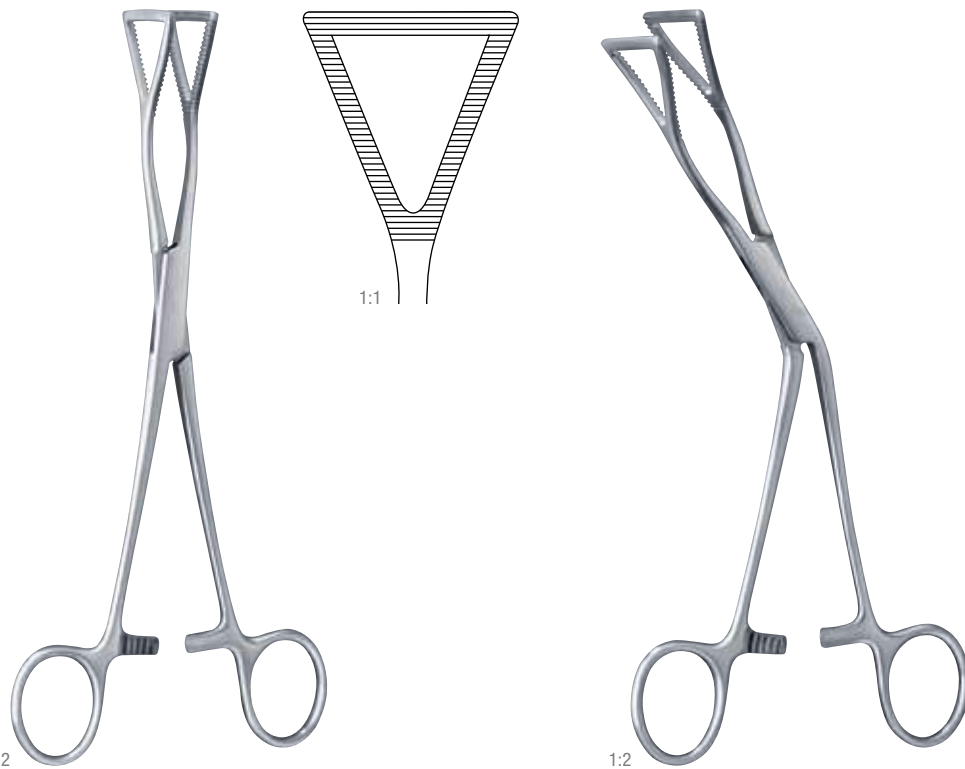

LOVELACE

1:2

1:2

200 mm – 8"

355-286-200

355-287-200

Arterienklemmen

Haemostatic forceps

Bronchus- und Gefäßklemmen

Bronchus and vascular clamps

Pinces vasculaires et pour bronches
Pinzas vasculares y bronquiales
Pinze vascolari e per bronchi



1:2

PRICE-THOMAS

1:1

220 mm – 8 3/4"

355-305-220

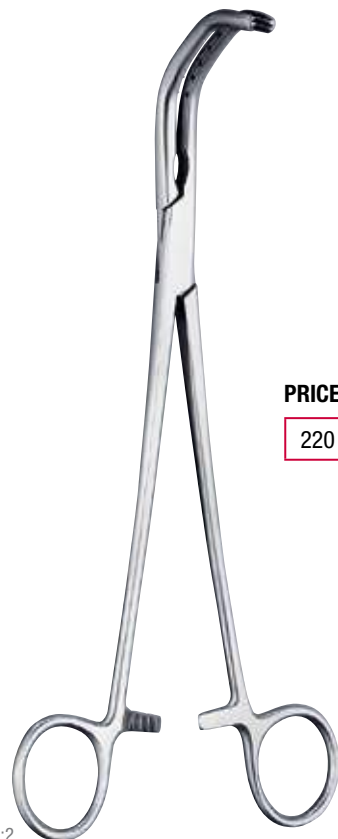
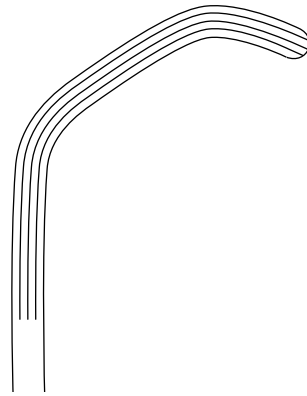

1:2

PRICE-THOMAS

1:1

220 mm – 8 3/4"

355-307-220

1:1

355-309-220

Stifte links
 Pins left
 Goupilles à gauche
 Pernos izquierda
 Perni a sinistra

Stifte rechts
 Pins right
 Goupilles à droit
 Pernos derecha
 Perni a destra

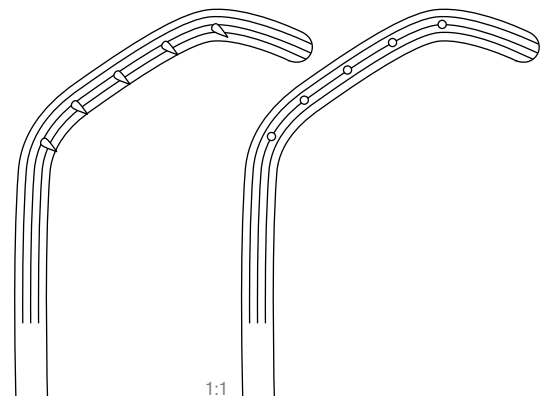

Bronchus- und Gefäßklemmen

Bronchus and vascular clamps

Pinces vasculaires et pour bronches
Pinzas vasculares y bronquiales
Pinze vascolari e per bronchi



1:2

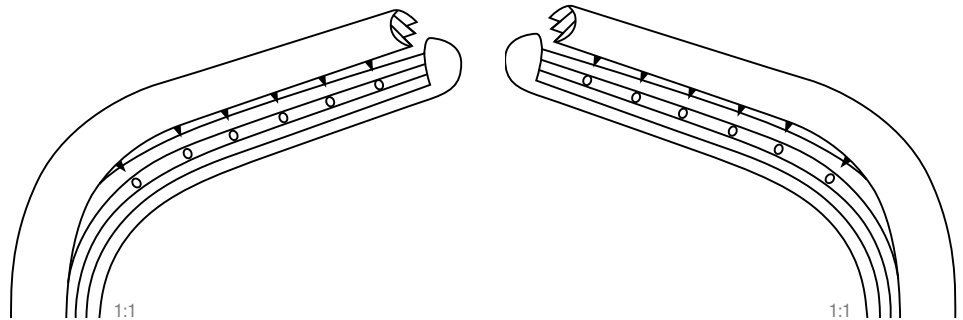

SAROT

230 mm – 9"

355-313-230

355-315-230

Stifte links

Pins left
 Goupilles à gauche
 Pernos izquierda
 Perni a sinistra

Stifte rechts

Pins right
 Goupilles à droit
 Pernos derecha
 Perni a destra



1:2

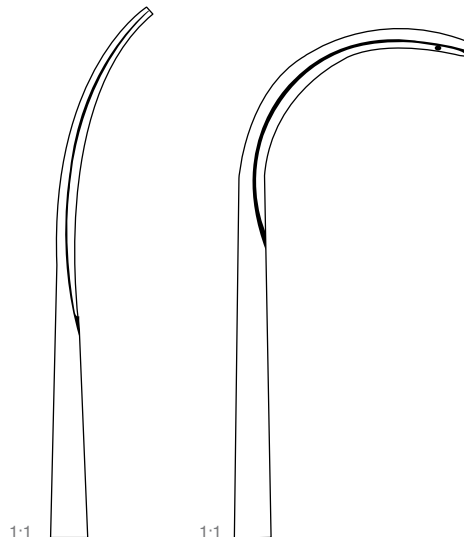

SEMB

1:1

1:1

240 mm – 9½"

355-317-

355-319-230

230

Arterienklemmen

Haemostatic forceps

Bronchus- und Gefäßklemmen

Bronchus and vascular clamps

Pinces vasculaires et pour bronches
Pinzas vasculares y bronquiales
Pinze vascolari e per bronchi



BABY-SATINSKY

1:1

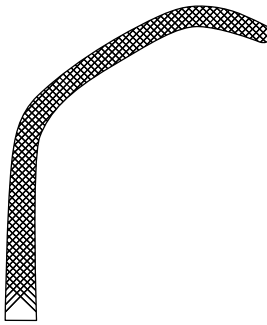

150 mm – 6"

355-321-150



SATINSKY

1:1

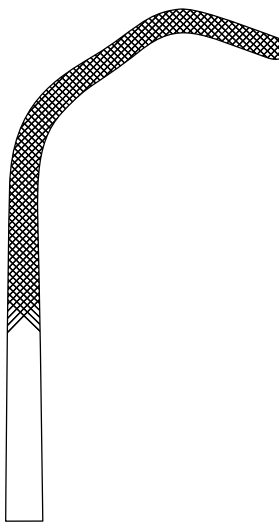

1:1

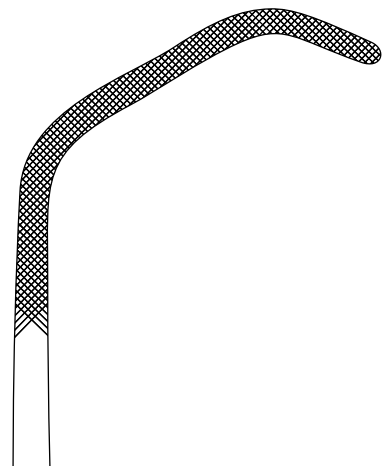

	Fig. 1	Fig. 1	Fig. 2	Fig. 2
265 mm – 10½"	355-323-260	355-327-260	355-325-260	355-329-260

S-förmig gebogen
 S-curved
 coube en S
 curva en S
 curva a forma di S

S-förmig gebogen
 S-curved
 coube en S
 curva en S
 curva a forma di S

1:2

Tuchklemmen
Towel forceps
Pinces à champs
Pinzas de campo
Pinze fissateli

BERNHARD

100 mm – 4 "	313-136-100
120 mm – 4 ¾ "	313-136-120
140 mm – 5 ½ "	313-136-140
165 mm – 6 ½ "	313-136-160
180 mm – 7 "	313-136-180

BACKHAUS

80 mm – 3 "	16-251-080
90 mm – 3 ½ "	16-251-090
110 mm – 4 ¼ "	16-251-110
130 mm – 5 "	16-251-130
150 mm – 6 "	16-251-150

ROEDER

130 mm – 5 "	16-255-130
150 mm – 6 "	16-255-150



1:2

110 mm – 4 "	313-111-110
--------------	-------------

 mit Schlauchhalter
 with clip for tube
 avec porte-tuyeau
 con soporte de tubo
 con supporto per tubo

Arterienklemmen

Haemostatic forceps

Tuchklemmen

Towel forceps

Pinces à champs

Pinzas de campo

Pinze fissateli



ROBIN 1:2

135 mm – 5 ¼"	16-247-135
---------------	------------

mit Schlauchhalter bis 5 mm Ø
with clip for tube up to 5 mm Ø
avec porte-tuyeau à 5 mm Ø
con soporte de tubo hasta 5 mm Ø
con supporto per tubo fino a 5 mm Ø



JONES

50 mm – 2"	16-227-060
90 mm – 3 ½"	16-227-090



SCHAEDEL 1:2

90 mm – 3 ½"	16-221-090	16-220-090
--------------	------------	------------

gerade
straight
droit
recta
retto



DOYEN 1:2

180 mm – 7"	16-229-180
-------------	------------



LORNA

100 mm – 4"	16-261-100
130 mm – 5"	16-261-130

Tuchklemmen

Towel forceps

Pinces à champs

Pinzas de campo

Pinze fissateli



LANE

130 mm – 5"	313-160-130
150 mm – 6"	313-160-150
200 mm – 8"	313-160-200



TOHOKU-JAPAN

100 mm – 4"	412-919-100
130 mm – 5"	412-919-130



1:2

PEERS-BERTRAM

145 mm – 5¾"	412-919-140
--------------	-------------



110 mm – 4¾"	313-119-110
130 mm – 5"	313-119-130

für Papierabdeckung

for paper clothes
 pour couvertures en papier
 para paños de papel
 per copertura di carta

Arterienklemmen

Haemostatic forceps

Schlauchklemmen
Tubing clamps
Presse-tubes
Pinzas para tubos
Pinze serratubi



150 mm – 6"	311-706-150
160 mm – 7"	311-706-180
190 mm – 8"	311-706-200

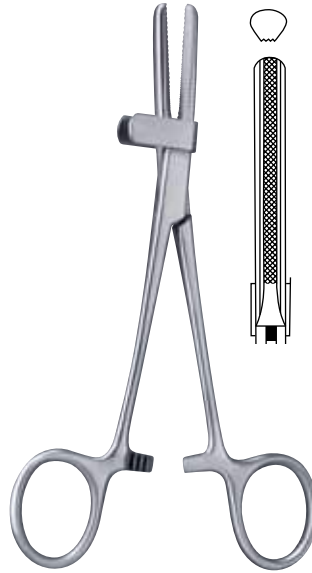

150 mm – 6"	311-708-150
180 mm – 7"	311-708-180
200 mm – 8"	311-708-200

mit Schutzbügel
 with protection
 avec protection
 con protector
 con protettore



165 mm – 6½"	12-984-165
180 mm – 7"	12-984-180



1:2
KLINIKUM-BERLIN

145 mm – 5¾"	12-980-145
--------------	------------

mit extra langer Sperre
 with extra long ratchet
 avec crémaillère extra longue
 con cremallera extra larga
 con cremagliera extra lunga



1:2
GUNNAR

185 mm – 7¼"	12-950-180
--------------	------------